

# DCR

INSPECTION SYSTEMS LTD

Hire  
Sales  
Refurbished  
Service



# DCR CUSTOM VAN FITS

INSPECTION SYSTEMS LTD



DCR Inspection Systems offer a full van kit out. We design and build custom vans that meet our customers' requirements from start to finish. We can even include all pipe inspection equipment. **Please call us on 01443 841540** for more information or to see photos of our previous work.



- ### Van Fit Build Options
- Fully customisable
  - Office Space
  - Sensored LED lighting
  - Leisure battery & inverter
  - Roof top beacons
  - Rear door beacons
  - Hand wash station
  - Sliding equipment rail
  - Storage cabinets
  - Rear spotlights



[www.draincamerarepairs.co.uk](http://www.draincamerarepairs.co.uk)

01443841540

\*All prices exclude VAT

# PIPE LINING EQUIPMENT

## 25kg Polymer Resin Kegs



## 5kg Tubs of Resin Hardener



## Flexible Liners



Available in:

- 100mm x 3mm x 100m
- 150mm x 3mm x 100m

## Light Duty Calibration Hoses



Available in:

- 100mm x 50m
- 100mm x 100m
- 150mm x 50m
- 150mm x 100m

## Medium Duty Calibration Hoses



Available in:

- 100mm x 100m
- 150mm x 100m

## 5kg Tubs of Resin Accelerator



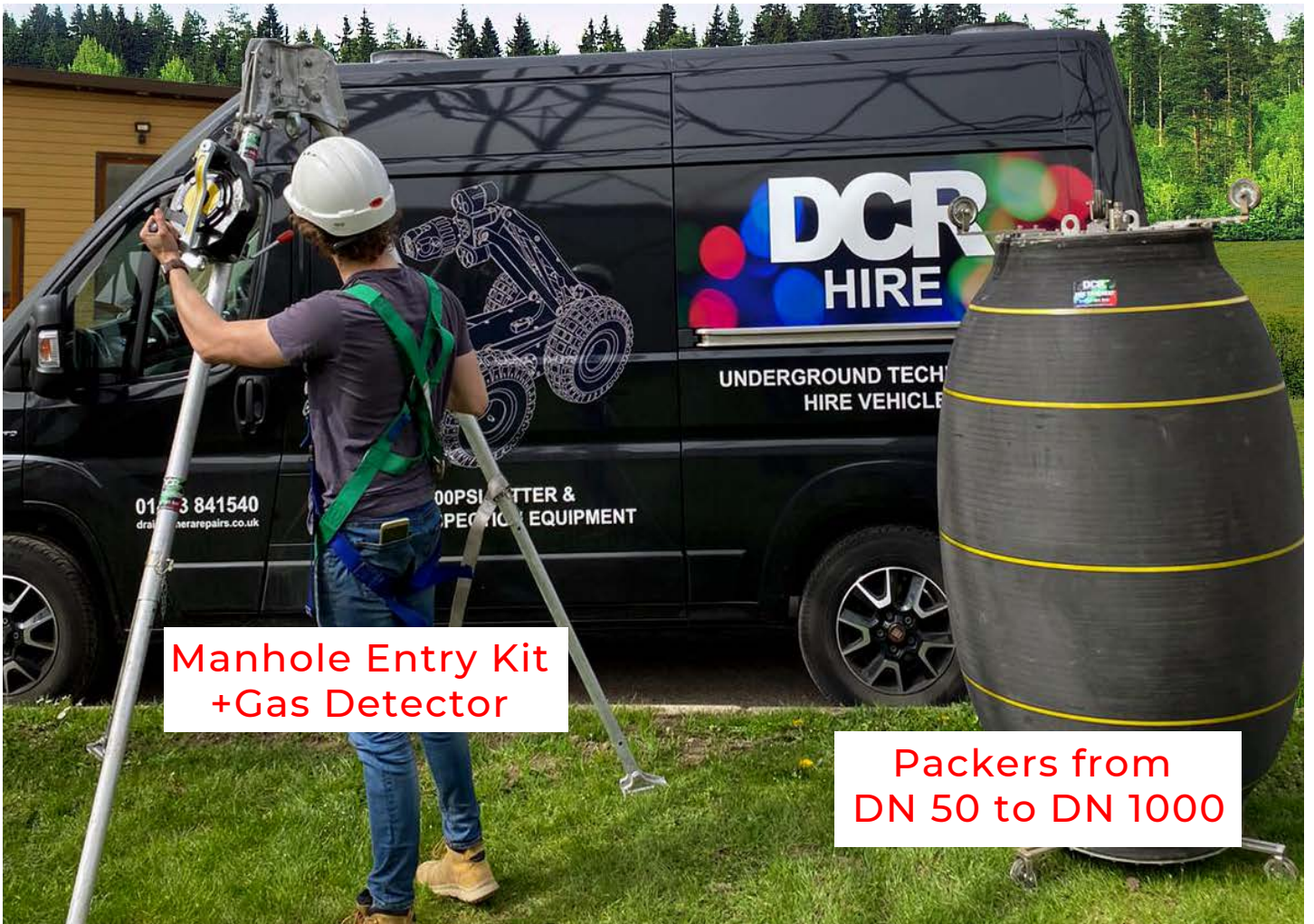

**Manhole Entry Kit  
+Gas Detector**

**Packers from  
DN 50 to DN 1000**

**LONG TERM HIRE AND PRICES AVAILABLE ON REQUEST**

For full hire rates and terms and conditions please visit our website at [www.draincamerarepairs.co.uk/hire](http://www.draincamerarepairs.co.uk/hire)

[www.draincamerarepairs.co.uk](http://www.draincamerarepairs.co.uk) 01443841540 \*All prices exclude VAT



# OUR HIRE RANGE

**DCR COMPLETE VAN WITH 3000-PSI JETTING UNIT AND MINICAM COMPATIBILITY**



**CCTV VAN**  
(CCTV equipment not included) **FROM £500.00**

**CCTV VAN WITH JETTER**  
(CCTV equipment not included) **FROM £695.00**



**LONG TERM PRICES AVAILABLE ON REQUEST**

## **ATEX ZONE 1 PROTEUS SYSTEM 250M**

**Prices start from £600.00**



- Atex Zone 1 certified
- 250m Cable
- DN:150 to 550
- Battery powered (4-5 hours)
- Built in multi frequency sonde
- Wincan and Pro Pipe embedded

## **FRESH WATER PROTEUS SYSTEM 250M**

**Prices start from £600.00**



- Dedicated for fresh water use only
- 250m Cable
- DN:150 to 550
- Battery powered (4-5 hours)
- Built in multi frequency sonde
- Wincan and Pro Pipe embedded

## **PROTEUS LITE CRAWLER SYSTEM 250M**

**Prices start from £360.00**



- 250m Cable
- DN:150 to 550
- Built in multi frequency sonde
- Full accessory box included
- Wincan and Pro Pipe embedded

## **PORTABLE PROTEUS SYSTEM 250M**

**Prices start from £410.00**



- 250m Cable
- DN:150 to 550
- Battery powered (4-5 hours)
- Built in multi frequency sonde
- All terrain portable trolley
- Wincan and Pro Pipe embedded

**LONG TERM HIRE AND PRICES AVAILABLE ON REQUEST**

For full hire rates and terms and conditions please visit our website at [www.draincamerarepairs.co.uk/hire](http://www.draincamerarepairs.co.uk/hire)

### CRAWLER SYSTEM WITH 350M CABLE

**Prices start from £510.00**



- 350M cable
- DN:150 to 550
- Full accessory box included
- Wincan and Pro Pipe embedded

### CRAWLER SYSTEM WITH 500M CABLE

**Prices start from £600.00**



- 500M cable
- DN:150 to 550
- Full accessory box included
- Wincan and Pro Pipe embedded

### PROTEUS 350M CABLE ONLY

**Prices start from £195.00**



- 350m cable

### PROTEUS 500M CABLE ONLY

**Prices start from £285.00**



- 500m cable

### CRP90 CRAWLER BODY & HEAD

**Prices start from £195.00**

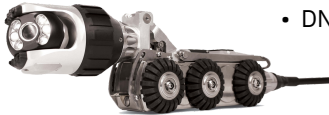

- 6 X QRWX60SR 60mm rubber wheels
- DN: 100 to 150

### CRP140 (6" to 22") PROTEUS CRAWLER & CAMERA HEAD

**Prices start from £195.00**

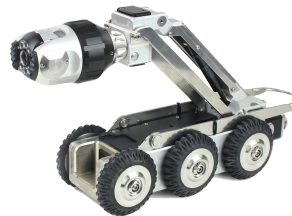

- 6 X 90mm rubber wheels
- DN: 150 to 550

### CRP300 (22" to 87") PROTEUS CRAWLER & CAMERA HEAD

**Prices start from £240.00**



- 4 X nematic all terrain wheels
- DN: 550 to 2200

### PORTABLE PROTEUS BATTERY PACK

**Prices start from £20.00**



- 4-5 hours battery life
- Portable carry case included

**LONG TERM HIRE AND PRICES AVAILABLE ON REQUEST**

For full hire rates and terms and conditions please visit our website at [www.draincamerarepairs.co.uk/hire](http://www.draincamerarepairs.co.uk/hire)

### PROTEUS AUXILIARY LIGHT HEAD/REAR CAMERA

**Prices start from £20.00**



- 3 high powered ultra-bright LED lights
- Reversing camera

### PROTEUS CRAWLER CRADLE ONLY

**Prices start from £195.00**



- Compatible with Minicam CRP140 and CPL150
- DN: 550 to 1200

### FRESH WATER SOLO PRO+ SYSTEM

**Prices start from £195.00**



- Dedicated for fresh water use only
- 60m coil
- Self levelling head
- Wincan and Pro Pipe embedded
- 4-5 hours battery life

### LARGE PUSH ROD SYSTEM 120M

**Prices start from £95.00**



- 150m coil
- SD card reader
- Self levelling head
- 4-5 hours battery life

### SOLO PRO+ SYSTEM (60M)

**Prices start from £120.00**



- 60m coil
- Self levelling head
- Wincan and Pro Pipe embedded
- 4-5 hours battery life

### SOLO PRO+ SYSTEM (60M) WITH PAN & TILT CAM

**Prices start from £290.00**



- 60m coil
- Pan & tilt camera head
- Wincan and Pro Pipe embedded
- 4-5 hours battery life

### IBOS R250 SYSTEM (80M)

**Prices start from £120.00**



- 80m coil
- SD card reader
- Self levelling head
- 4-5 hours battery life

### SOLOPRO+ MINI REEL

**Prices start from £105.00**



- For DN30 to DN100 pipes
- Ideal for inspections in confined spaces

**LONG TERM HIRE AND PRICES AVAILABLE ON REQUEST**

For full hire rates and terms and conditions please visit our website at [www.draincamerarepairs.co.uk/hire](http://www.draincamerarepairs.co.uk/hire)

### MILWAUKEE HANDHELD CAMERA

**Prices start from £50.00**



- Range of 3 metres
- 4 x zoom & screen rotation
- Highly durable & manoeuvrable

### MILWAUKEE M18 FUEL AIR COMPRESSOR

**Prices start from £30.00**



- 9.31 bar maximum pressure
- Exceptional run times

### MILWAUKEE FLEXISHAFT

**Prices start from £100.00**



- 23m long cable
- Up to 2,200rpm
- DN32 - 100

### CAMERA FLOATATION RAFT

**Prices start from £60.00**

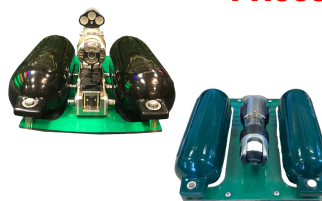

- Large (W)50cm x (H)18cm x (L)56cm
- Small (W)40cm x (H)10cm x (L)40cm

### PICOTE GRABBER

**Prices start from £150.00**



- 10m range
- 10m extension available

### PICOTE MILLER RANGE

**Prices start from £265.00**



- High speed cleaning
- Removes blockages
- DN50 - 250 / 2" - 10" pipes.

### 33KHZ, 512KHZ & 33 KHZ SUPER SONDE

**Prices start from £15.00**



- 512KHZ: 5-6m depth
- 33KHZ: 3-4m depth
- Super: 15m depth

### MILWAUKEE PLUMBING LOCATOR

**Prices start from £50.00**



- Multi-frequency locating
- On screen depth measurement
- Locating markers

### CONTROL UNIT ONLY

**Prices start from £75.00**



- SD card reader
- 4-5 hours battery life

### PITCH FIBRE RE-ROUNDER 4", 6", and 9"

**Prices start from £310.00**



- Re-rounds 4", 6" and 9" pipes
- 30m winch
- 10 tonne pulling capacity

**LONG TERM HIRE AND PRICES AVAILABLE ON REQUEST**

For full hire rates and terms and conditions please visit our website at [www.draincamerarepairs.co.uk/hire](http://www.draincamerarepairs.co.uk/hire)



### FULL ESCAPE KIT INCLUDING GAS DETECTOR

**Prices start from £50.00**



- 10 minute escape time
- Gas detection meter

### INSPECTION CHAMBER ENTRY KIT INCLUDING TRIPOD, WINCH, HARNESS, MAN RIDING AND PERSONNEL WINCH

**Prices start from £50.00**



- 15m fall arrest winch
- Rescue harness

### COMPACT TRANSFER PUMP

**Prices start from £30.00**



- Pumps 1,817 litres every hour
- Can transfer 908 litres of water with one fully charged M18 5.0Ah battery

### GENERATOR EU22i HONDA

**Prices start from £60.00**



- 2200W petrol generator
- Honda GXR120 121cc quiet fuel-efficient performance in small, lightweight package

### KEYTEC MEGA DUTY SET

**Prices start from £75.00**



- 125kg weight limit
- 1m tip range

### MILWAUKEE M18 DRAIN CLEANER

**Prices start from £30.00**



- Suitable for pipes between DN32 and DN75 and has a maximum range of 15m.

### CABLE GUIDE PULLEY / MANHOLE TOP ROLLER

**Prices start from £15.00**



- Top and bottom guide roller

### RIDGID K9-102/204 FLEXSHAFT DRAIN CLEANING MACHINE

**Prices start from £50.00**



- |               |               |
|---------------|---------------|
| <b>K9-102</b> | <b>K9-204</b> |
| •DN:30 to 50  | •DN:50 to 100 |
| •15m coil     | •21m coil     |

### LINING PACKER INFLATION KIT WITH COMPRESSOR

**Prices start from £95.00**



- 10x 1.5m air rods

### KOSHIN KYH-50X COMPACT TRASH PUMP

**Prices start from £50.00**



- Honda GX160 4-stroke engine
- 3.6 litre tank
- 3 hour running time (approx)

**LONG TERM HIRE AND PRICES AVAILABLE ON REQUEST**

For full hire rates and terms and conditions please visit our website at [www.draincamerarepairs.co.uk/hire](http://www.draincamerarepairs.co.uk/hire)



## STANDARD PATCH LINING PACKERS

### DCR STANDARD PACKERS

### 7 Day Hire Rate:

### Purchase Price:

Standard lateral packer 1000mm long DN50/DN70	£50.00	£149.06
Standard lateral packer 1000mm long DN50/DN70	£50.00	£154.14
Standard lateral packer 1000mm long DN70/DN100	£50.00	£161.04
Standard lateral packer 1500mm long DN70/DN100	£50.00	£203.88
Standard lateral packer 2000mm long DN70/DN100	£50.00	£246.72
Standard lateral packer 2500mm long DN70/DN100	£50.00	£282.86
Standard lateral packer 600mm long DN100/DN150	£50.00	£183.32
Standard lateral packer 1000mm long DN100/ DN150	£50.00	£219.30
Standard lateral packer 1500mm long DN100/DN150	£50.00	£243.28
Standard lateral packer 2000mm long DN100/DN150	£50.00	£303.24
Standard lateral packer 1000mm long DN150/DN250	£50.00	£284.40
Standard lateral packer 1500mm long DN150/DN250	£50.00	£352.94
Standard lateral packer 2000mm long DN150/DN250	£100.00	£421.46
Standard lateral packer 1000mm long DN200/DN300	£50.00	£376.92
Standard lateral packer 1500mm long DN200/DN300	£100.00	£414.62
Standard lateral packer 2000mm long DN200/DN300	£100.00	£486.58
Standard lateral packer 1500mm long DN300/DN400	£100.00	£812.10
Standard lateral packer 2000mm long DN300/DN400	£100.00	£860.06
Standard lateral packer 3000mm long DN300/DN400	£150.00	£968.84
Standard lateral packer 2000mm long DN400/DN500	£150.00	£968.00
Standard lateral packer 3000mm long DN400/DN500	£150.00	£1,165.32
Standard lateral packer 1500mm long DN400/DN600	£200.00	£873.78
Standard lateral packer 1500mm long DN500/DN600	£200.00	£932.02
Standard lateral packer 3000mm long DN500/DN600	£200.00	£1,280.50





## WHEELED BYPASS PACKERS

### DCR WHEELED BYPASS PACKERS

**7 Day Hire Rate: Purchase Price:**

Wheeled and bypass packer 1000mm long DN100/DN150	<b>£100.00</b>	<b>£465.80</b>
Wheeled and bypass packer 1500mm long DN100/DN150	<b>£150.00</b>	<b>£509.84</b>
Wheeled and bypass packer 2000mm long DN100/DN150	<b>£150.00</b>	<b>£648.72</b>
Wheeled and bypass packer 2500mm long DN100/DN150	<b>£150.00</b>	<b>£757.12</b>
Wheeled and bypass packer 3000mm long DN100/DN150	<b>£150.00</b>	<b>£870.60</b>
Wheeled and bypass packer 1000mm long DN150/DN250	<b>£100.00</b>	<b>£753.74</b>
Wheeled and bypass packer 1500mm long DN150/DN250	<b>£150.00</b>	<b>£863.84</b>
Wheeled and bypass packer 2000mm long DN150/DN250	<b>£150.00</b>	<b>£924.80</b>
Wheeled and bypass packer 2500mm long DN150/DN250	<b>£200.00</b>	<b>£1,058.62</b>
Wheeled and bypass packer 3000mm long DN150/DN250	<b>£200.00</b>	<b>£1,197.50</b>
Wheeled and bypass packer 1000mm long DN200/DN300	<b>£150.00</b>	<b>£809.64</b>
Wheeled and bypass packer 1500mm long DN200/DN300	<b>£200.00</b>	<b>£884.16</b>
Wheeled and bypass packer 2000mm long DN200/DN300	<b>£200.00</b>	<b>£973.92</b>
Wheeled and bypass packer 3000mm long DN200/DN300	<b>£250.00</b>	<b>£1,311.00</b>
Wheeled and bypass packer 1000mm long DN300/DN400	<b>£200.00</b>	<b>£863.84</b>
Wheeled and bypass packer 1500mm long DN300/DN400	<b>£200.00</b>	<b>£979.00</b>
Wheeled and bypass packer 3000mm long DN300/DN400	<b>£200.00</b>	<b>£1,762.64</b>
Wheeled and bypass packer 1500mm long DN400/DN600	<b>£500.00</b>	<b>£872.00</b>
Wheeled and bypass packer 1500mm long DN600/DN800	<b>£500.00</b>	<b>£2,201.92</b>
Wheeled and bypass packer 2000mm long DN600/DN800	<b>£500.00</b>	<b>£2,879.44</b>
Wheeled and bypass packer 3000mm long DN600/DN800	<b>£500.00</b>	<b>£3,811.02</b>





## RADIUS PACKERS

<b>DCR RADIUS PACKERS</b>	<b>7 Day Hire Rate:</b>	<b>Purchase Price:</b>
Radius Packer 600mm long DN100	<b>£50.00</b>	<b>£262.50</b>
Radius Packer 1000mm long DN100	<b>£50.00</b>	<b>£332.80</b>
Radius Packer 1500mm long DN100	<b>£50.00</b>	<b>£332.80</b>
Radius Packer 600mm long DN150	<b>£100.00</b>	<b>£395.88</b>
Radius Packer 1000mm long DN150	<b>£100.00</b>	<b>£452.31</b>
Radius Packer 1500mm long DN150	<b>£100.00</b>	<b>£452.31</b>
Radius Packer 1500mm long DN300	<b>£150.00</b>	<b>£1,470.00</b>

<b>DCR PIPE PLUGS</b>	<b>7 Day Hire Rate:</b>	<b>Purchase Price:</b>
Pipe Plug DN35-70	<b>£30.00</b>	<b>£72.84</b>
Pipe Plug DN50-100	<b>£30.00</b>	<b>£72.84</b>
Pipe Plug DN70-150	<b>£30.00</b>	<b>£83.00</b>
Pipe Plug DN100-200	<b>£30.00</b>	<b>£93.16</b>
Pipe Plug DN150-300	<b>£40.00</b>	<b>£137.20</b>
Pipe Plug DN200-400	<b>£50.00</b>	<b>£162.60</b>
Pipe Plug DN200-500	<b>£60.00</b>	<b>£216.80</b>
Pipe Plug DN300-600	<b>£60.00</b>	<b>£240.00</b>
Pipe Plug DN375-750	<b>£125.00</b>	<b>£575.88</b>
Pipe Plug DN400-800	<b>£150.00</b>	<b>£846.90</b>
Pipe Plug DN500-1000	<b>£270.00</b>	<b>£1,075.56</b>
Pipe Plug DN600-1200	<b>£280.00</b>	<b>£2,710.06</b>
Pipe Plug DN600-1600	<b>£300.00</b>	<b>£3,794.08</b>
Pipe Plug DN800-1600	<b>£320.00</b>	<b>£4,200.59</b>
Pipe Plug DN800-1800	<b>£340.00</b>	<b>£4,742.60</b>
Pipe Plug DN800-2000	<b>£350.00</b>	<b>£5,555.63</b>
Pipe Plug DN800-2200	<b>£280.00</b>	<b>£2,749.00</b>
Pipe Plug DN600-900 (Rectangular)	<b>£280.00</b>	<b>£2,749.00</b>



## Our Service Centre

DCR has been repairing and servicing drain cameras for more than 15 years! In fact, DCR stands for 'drain camera repairs'. It's fair to say we've grown somewhat since, but we originally offered repairs and servicing exclusively and, as a result, have years of experience with every drain camera you could imagine! Our team are fully trained and qualified, and capable of undertaking repairs at a component level. This means that we're able to repair the vast majority of PCB boards, saving our customers money in the process. We are authorised to repair – and stock official parts for – Minicam, Milwaukee, Dancutter, Picote, RIDGID, Riezler, Ibos, and C.Scope equipment.

## Customer Service

Following your equipment having arrived at DCR, our technicians will undertake robust diagnostics. Once the fault and a remedy have been identified, we will send you a no-obligation quote describing any problems your system has, what we will do to fix them and the cost of all repairs. Customers typically receive this within 2 working days of us receiving their system.

We are also able to offer a same-day repair service to customers looking to avoid as much downtime as possible. This will need to be booked in advance and is subject to availability – Please call 01443 841540 or email [service@draincamerarepairs.co.uk](mailto:service@draincamerarepairs.co.uk) to ensure we are able to offer a same-day repair before arriving with your equipment.

## What We Offer

Our customers are our top priority and everything we do revolves around them. Our goal is to make it both easy and convenient for you to get your equipment repaired or serviced. This is why we'll even collect your damaged equipment on your behalf; simply pack it up or palletise it, send us your details, and we'll get it collected and delivered straight to our workshop.





# CoverUp Key

The safest and fastest way to move stubborn covers



The current, traditional techniques of releasing stubborn manhole covers have been shown to have negative health and safety implications.



**ALWAYS HAMMERING DOWN?  
START HAMMERING UP!**

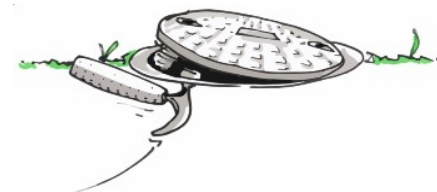

The CoverUp Key provides a one-man solution to allow stuck manholes to be released without chiselling or hammering. Its patented slide hammer exerts a momentary upward force capable of releasing stuck, jammed and rusted chamber covers quickly, efficiently and safely.

Watch our introductory video on the website. There are interchangeable tips available.

Visit us @

[www.coverupkey.uk](http://www.coverupkey.uk)

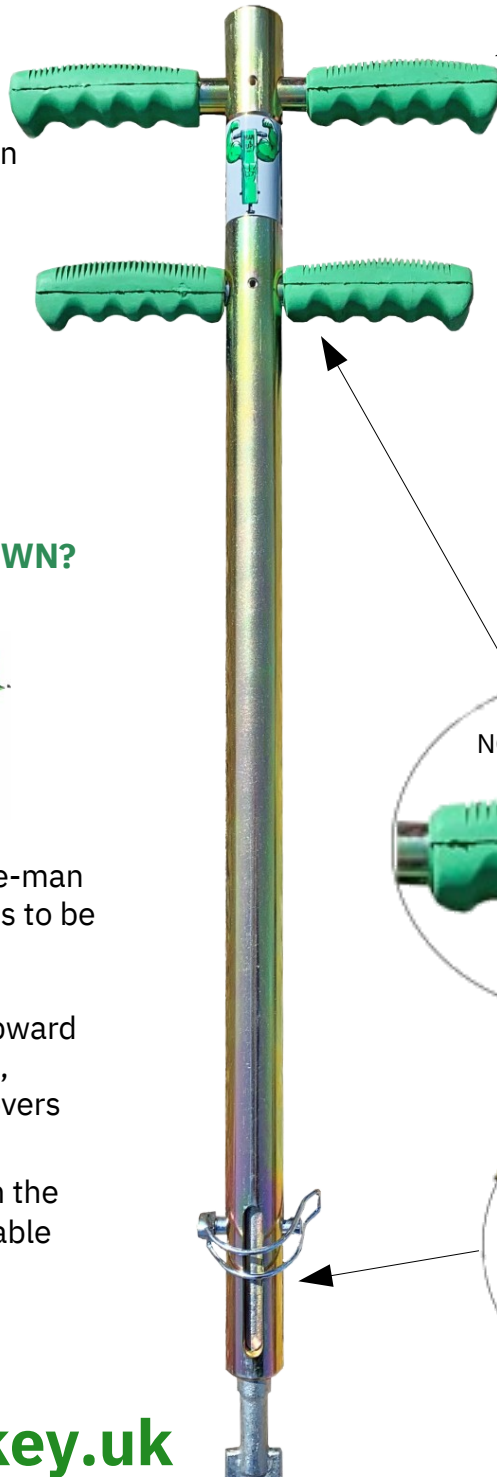

EXTRA HANDLES FOR EASIER LIFTING AND KEEPING GOOD POSTURE

SUPPLIED WITH CASE



NON SLIP SOFT GRIP RUBBER



MULTI DIRECTIONAL INTERCHANGEABLE TIPS

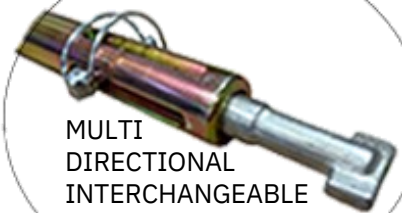

***“After opening the packaging, it was immediately obvious of improvements that had been made to the design of the product, now allowing two different handle heights to accommodate the differences in the operational teams. This now makes the CoverUp Key more universally usable! I am extremely happy with improvements that have been made to the CoverUp Key, particularly the effectiveness of lifting heavy man hole covers safely and in the correct position.” - FMCONWAY***



# From CoverUp Key



## The CoverUp Lifter

Made in the UK

### Introducing the newest member of the CoverUp Key range!

The only height adjustable lifter with interchangeable tips and clips.

Lift all types of access cover safely whilst maintaining posture!

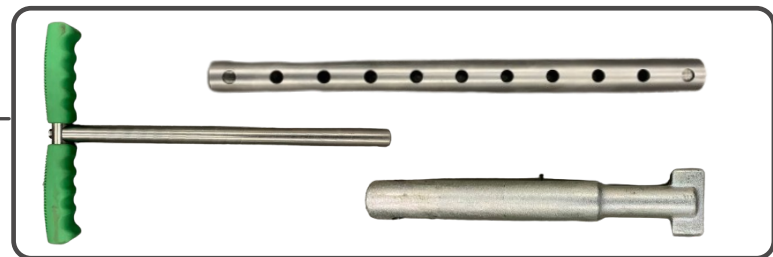
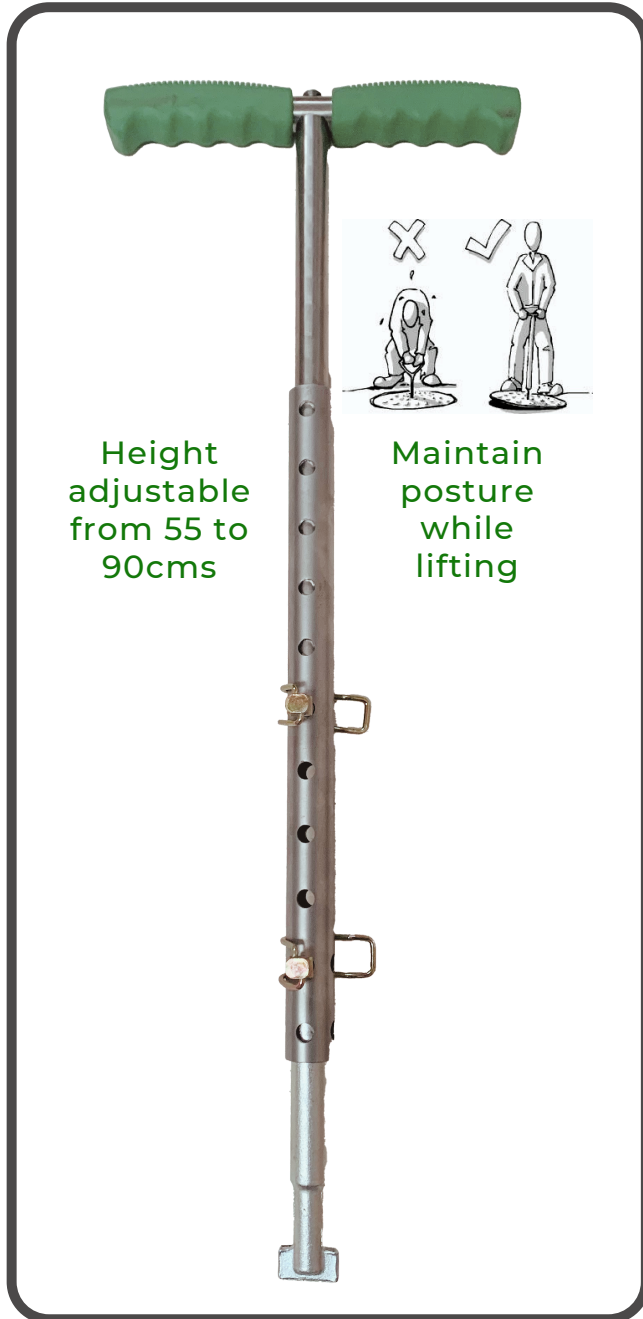

Height adjustable to accommodate all users.

All CoverUp Key tips are compatible with this lifter

**Change the tips and not the key with the tool that will lift for a lifetime!**

**More information at [www.coverupkey.com](http://www.coverupkey.com)**



# From CoverUp Key



Developed with



## The Fire Hydrant Set For Light Covers and Valves

Used by



32mm Flat and 22mm Flat Tips conveniently stored within the bar

Designed in conjunction and approved for use with UK Fire & Rescue Services, the Fire Hydrant CoverUp Key Set is a combined access cover removal tool and hydrant valve tool in a single, compact and quickly deployable tool. The tool has storage for 2 CoverUp Key flat tips, a 50mm square valve key, and an extra long removable handle to provide extra leverage when opening valves.

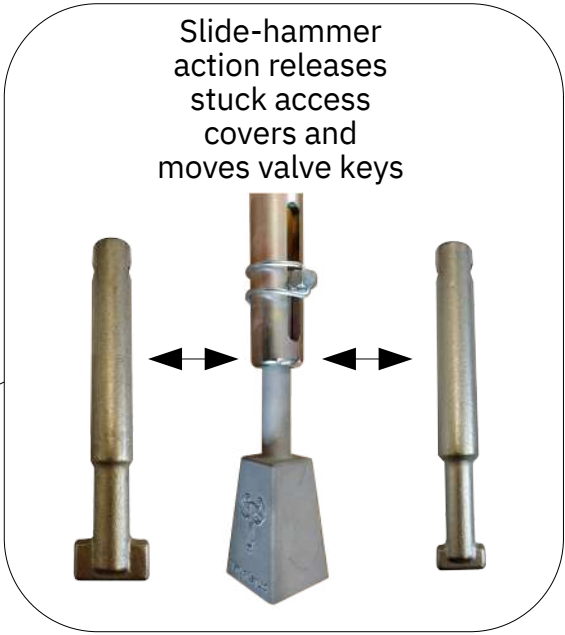

Slide-hammer action releases stuck access covers and moves valve keys

### Fire Hydrant Set - GBFHSET

Bar Length	900mm
Handle Length	640mm
Weight	6.2kg
Material	Plated Steel

<b>1: UK Fire Engine Storage Position</b>	<b>2: Removable Handle</b>	<b>3: For opening &amp; closing valves</b>	<b>4: For opening stuck access covers</b>





## CoverUp Key Industry Complete Sets

All kits include an accessory case and 2 retaining pins

### Starter Set

Item Code: **GBSTSET**

Includes:

- CoverUp Key Bar - 001BAR
- 32mm Flat Tip - 002F32

Tip Kit Only (No Bar): **GBSTKIT**

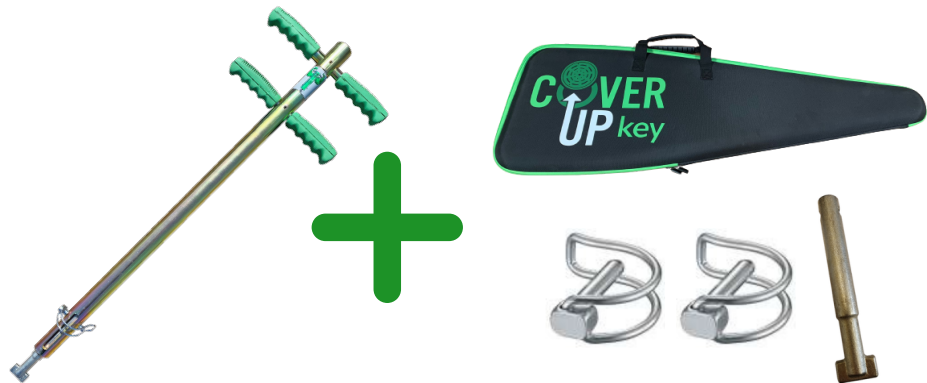

### Drainage Set

Item Code: **GBDRSET**

Includes:

- CoverUp Key Bar - 001BAR
- 32mm Flat Tip - 002F32
- 22mm Flat Tip - 003F22
- 12mm J Hook Tip - 017J12
- Cleaning Tip - 006J08

Tip Kit Only (No Bar): **GBDRKIT**



### Telecoms Set

Item Code: **GBTLSET**

Includes:

- CoverUp Key Bar - 001BAR
- 32mm Flat Tip - 002F32
- 22mm Flat Tip - 003F22
- 12mm J Hook Tip - 017J12
- 20mm Oval Tip - 009O20

Tip Kit Only (No Bar): **GBTKIT**

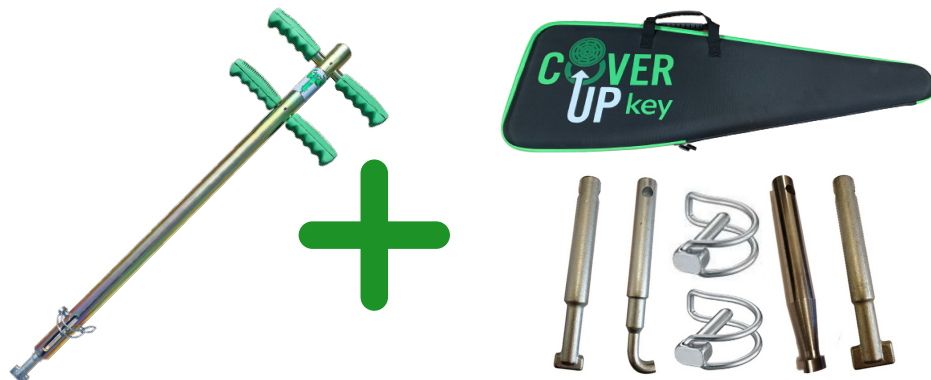



## CoverUp Key Industry Complete Sets

All kits include an accessory case and 2 retaining pins

### Electricity Set

Item Code: GBELSET

Includes:

- CoverUp Key Bar - 001BAR
- 22mm Flat Tip - 003F22
- 20mm Oval Tip - 009O20
- 12mm J Hook Tip - 017J12
- Cleaning Tip - 006J08

Tip Kit Only (No Bar): GBELKIT

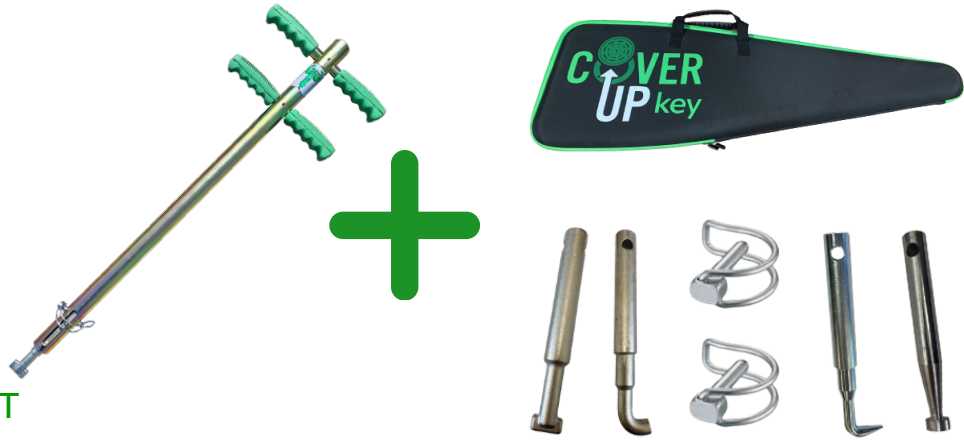

### Pest Control Set

Item Code: GBPCSET

Includes:

- CoverUp Key Bar - 001BAR
- 22mm Flat Tip - 002F22
- 32mm Flat Tip - 002F32
- 12mm J Hook Tip - 017J12
- 10mm Threaded Tip - 005T10
- 12mm Threaded Tip - 004T12

Tip Kit Only (No Bar): GBPCKIT



### Fresh Water Set

Item Code: GBFWSET

Includes:

- CoverUp Key Bar - 001BAR
- 32mm Flat Tip - 002F32
- 22mm Flat Tip - 003F22
- 12mm J Hook Tip - 007J12
- Cleaning Tip - 006J08
- Fire Hydrant Valve Key - 011HYD

Tip Kit Only (No Bar): GBFWKT





## CoverUp Key Industry Complete Sets

All kits include an accessory case and 2 retaining pins

### Gas Network Set

Item Code: **GBGNSET**

Includes:

- CoverUp Key Bar - 001BAR
- 32mm Flat Tip - 002F32
- 22mm Flat Tip - 003F22
- 12mm J Hook Tip - 017J12
- Cleaning Tip - 006J08
- Gas Valve Key - 011HYD

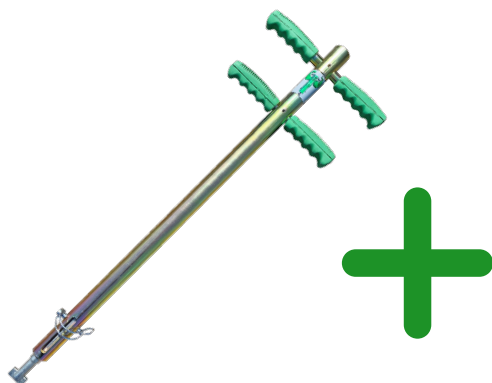

Tip Kit Only (No Bar): **GBGNKIT**

### US Water Set

Item Code: **USFSFSET**

Includes:

- CoverUp Key Bar - 001BAR
- 32mm Flat Tip - 002F32
- 22mm Flat Tip - 003F22
- 16mm J Hook Tip - 013J16
- Cleaning Tip - 006J08

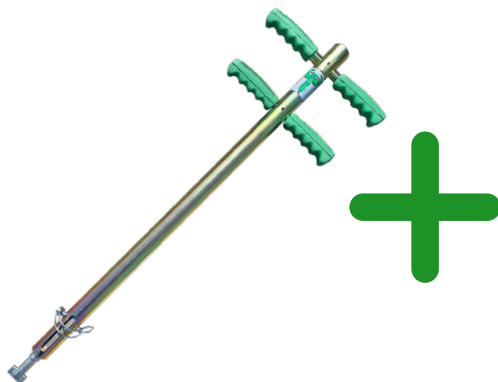

Tip Kit Only (No Bar): **USFWKIT**

### Australian Set

Item Code: **AUNZSET**

Includes:

- CoverUp Key Bar - 001BAR
- 31mm Oval Tip - 008O30
- 20mm Oval Tip - 009O20
- Cleaning Tip - 006J08
- 16mm J Hook Tip - 013J16
- 8mm C Hook Tip - 010CHK

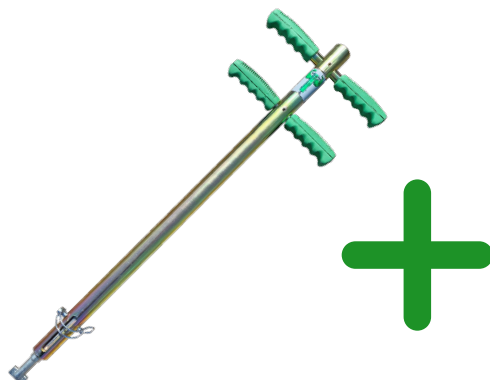

Tip Kit Only (No Bar): **AUNZKIT**



## CoverUp Key Industry Complete Sets

All kits include an accessory case and 2 retaining pins

### German Set

Item Code: **GERMSET**

Includes:

- CoverUp Key Bar - 001BAR
- 32mm Flat Tip - 002F32
- 12mm J Hook Tip - 017J12
- 16mm J Hook Tip - 013J16
- 8mm C Hook Tip - 010CHK



Tip Kit Only (No Bar): **GERMKIT**

### Full Set

Item Code: **FLLSET**

Includes:

- CoverUp Key Bar - 001BAR
- 22mm Flat Tip - 003F22
- 32mm Flat Tip - 002F32
- 12mm J Hook Tip - 017J12
- 16mm J Hook Tip - 013J16
- 8mm C Hook Tip - 010CHK
- Cleaning Tip - 006J08
- 10mm Threaded Tip - 005T10
- 12mm Threaded Tip - 004T12
- 20mm Oval Tip - 009O20
- 31mm Oval Tip - 008O30
- 20mm Gulley Tip - 019GLY
- Fire Hydrant Valve Key - 011HYD



Tip Kit Only (No Bar): **FLLKIT**

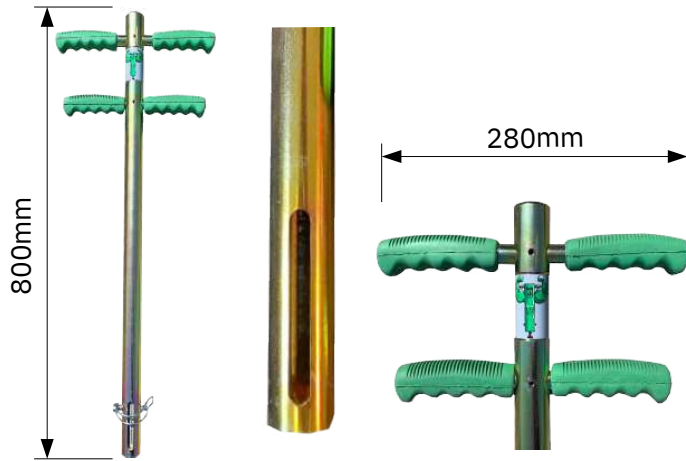

The CoverUp Key – A slide hammer action, access cover releasing tool for stuck or seized covers. The current design features an extra set of handles for the user to choose based on their preference, and the ability to insert tips in multiple orientations

### CoverUp Key – Bar Only – 001BAR

Dimensions (L x D)	800 x 35mm
Handle Width	280mm
Weight	6.6kg
Material	Plated Steel

Light Duty Medium Duty  Heavy Duty

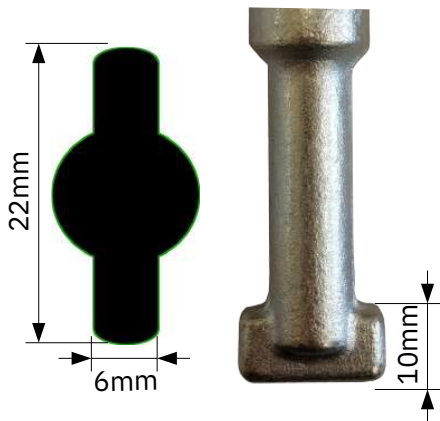

Designed to fit any access cover with a keyhole size of approximately 20mm.

#### Used with:

- Drainage
- Gas
- Electricity
- Telecoms
- Pest Control
- Fire Service
- Fresh Water

### 22mm Flat Tip - 003F22

Dimensions (L x D)	160 x 20mm
Head Size	22 x 6 x 10mm
Weight	0.3kg
Material	Hardened Steel

Light Duty  Medium Duty Heavy Duty

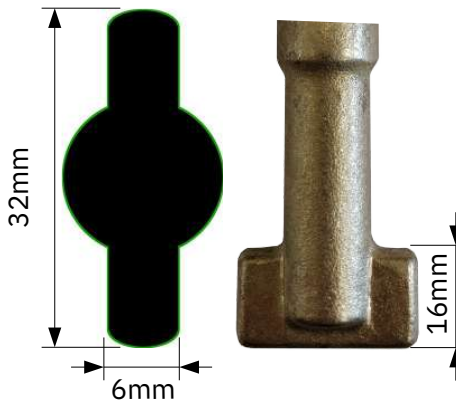

One of the most commonly used access cover keyhole shapes world-wide. Will fit most covers that have an approximately 30mm sized keyhole.

#### Used with:

- Drainage
- Gas
- Electricity
- Telecoms
- Pest Control
- Fire Service
- Fresh Water

### 32mm Flat Tip - 002F32

Dimensions (L x D)	160 x 20mm
Head Size	32 x 6 x 16mm
Weight	0.3kg
Material	Hardened Steel

Light Duty Medium Duty  Heavy Duty



An 8mm 'J' shaped hook, ideal for cleaning out the dirt and grit that becomes clogged in access cover keyholes over time.

#### Used with:

- Drainage
- Gas
- Electricity
- Telecoms
- Pest Control
- Fire Service
- Fresh Water

### 8mm Cleaning Tip - 006J08

Dimensions (L x D)	174 x 20mm
Head Size	20mm (L) x 8mm (D) 'J' Shape
Weight	0.3kg
Material	Hardened Steel

Light Duty Medium Duty Heavy Duty

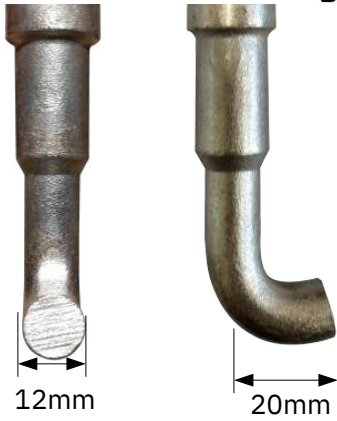

A 12mm 'J' shaped hook can be used on many different types of access covers and gulleys.

Used with:

- Drainage
- Gas
- Electricity
- Telecoms
- Pest Control
- Fire Service
- Fresh Water

**12mm J Tip - 017J12**

Dimensions (L x D)	174 x 20mm
Head Size	20mm (L) x 12mm (D) 'J' Shape
Weight	0.3kg
Material	Hardened Steel

Light Duty Medium Duty  Heavy Duty



A 16mm 'J' shaped hook can be used on many different types of access covers and gulleys.

Used with:

- Drainage
- Gas
- Electricity
- Telecoms
- Pest Control
- Fire Service
- Fresh Water

**16mm J Tip - 013J16**

Dimensions (L x D)	174 x 40mm
Head Size	40mm (L) x 16mm (D) 'J' Shape
Weight	0.3kg
Material	Hardened Steel

Light Duty Medium Duty  Heavy Duty

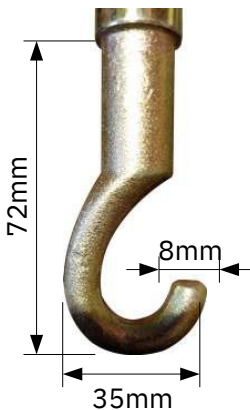

Generally used within the Australian market, 8mm 'C' Shaped Hook for use in many different kinds of light gully covers.

Used with:

- Drainage
- Gas
- Electricity
- Telecoms
- Pest Control
- Fire Service
- Fresh Water

**8mm Hooked Tip - 010CHK**

Dimensions (L x D)	182 x 20mm
Head Size	8mm Hook
Weight	0.3kg
Material	Hardened Steel

Light Duty Medium Duty Heavy Duty

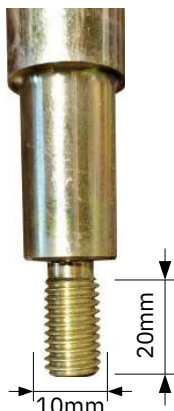

Designed for use on access covers commonly found indoors that have threaded keyholes.

Used with:

- Drainage
- Gas
- Electricity
- Telecoms
- Pest Control
- Fire Service
- Fresh Water

**10mm Threaded Tip - 005T10**

Dimensions (L x D)	160 x 20mm
Thread Size	M10 x 20mm
Weight	0.3kg
Material	Hardened Steel

Light Duty  Medium Duty Heavy Duty



Designed for use on access covers commonly found indoors that have threaded keyholes.

Used with:

- Drainage
- Gas
- Electricity
- Telecoms
- Pest Control
- Fire Service
- Fresh Water

**12mm Threaded Tip - 004T12**

Dimensions (L x D)	160 x 20mm
Thread Size	M12 x 20mm
Weight	0.3kg
Material	Hardened Steel
Light Duty <input type="checkbox"/> <input checked="" type="checkbox"/> Medium Duty <input type="checkbox"/> Heavy Duty	

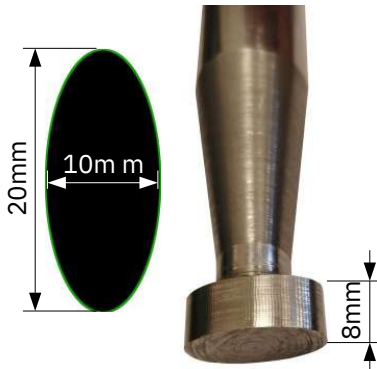

The 20mm Oval tip, originally designed for use with telecom access covers, will fit any access cover with a 20mm x 10mm oval shaped keyhole.

Used with:

- Drainage
- Gas
- Electricity
- Telecoms
- Pest Control
- Fire Service
- Fresh Water

**20mm Oval Tip - 009Ø20**

Dimensions (L x D)	160 x 20mm
Head Size	20mm (L) x 10mm (D) Oval Shape
Weight	0.3kg
Material	Hardened Steel
Light Duty <input type="checkbox"/> <input checked="" type="checkbox"/> Medium Duty <input type="checkbox"/> Heavy Duty	

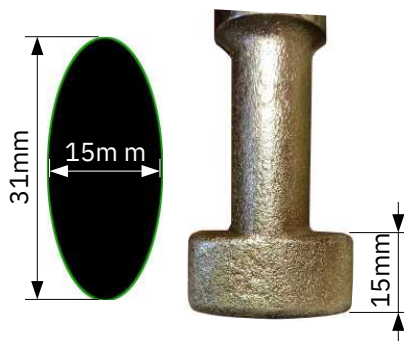

The 31mm Oval tip, originally designed for use in Australia, will fit any manhole or access cover with a 31mm x 15mm oval shaped keyhole.

Used with:

- Drainage
- Gas
- Electricity
- Telecoms
- Pest Control
- Fire Service
- Fresh Water

**31mm Oval Tip - 008Ø30**

Dimensions (L x D)	160 x 20mm
Head Size	31mm (L) x 15mm (D) Oval Shape
Weight	0.3kg
Material	Hardened Steel
Light Duty <input type="checkbox"/> Medium Duty <input type="checkbox"/> <input checked="" type="checkbox"/> Heavy Duty	

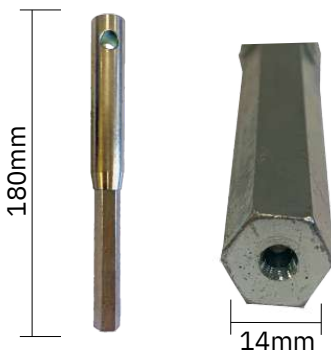

A 14mm Hex shaped tip, used to gain easier access to sealed or screwed down covers

Used with:

- Drainage
- Gas
- Electricity
- Telecoms
- Pest Control
- Fire Service
- Fresh Water

**14mm Hex key Tip - 022H14**

Dimensions (L x D)	180 x 14mm
Head Size	80mm (L) x 14mm (D)
Weight	0.3kg
Material	Hardened Steel
Light Duty <input type="checkbox"/> <input checked="" type="checkbox"/> Medium Duty <input type="checkbox"/> Heavy Duty	

# CoverUp Key

The safest and fastest way to move stubborn covers

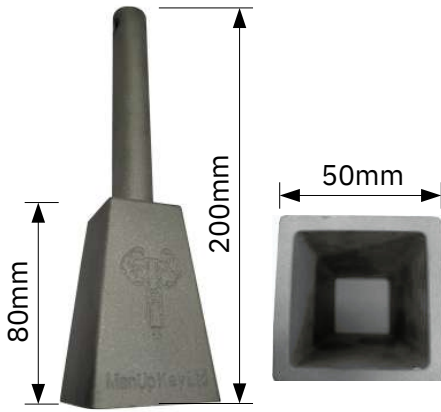

- Used with:
- Drainage
  - Gas
  - Electricity
  - Telecoms
  - Pest Control
  - Fire Service
  - Fresh Water

The stop tap valve key, designed specifically for use with the CoverUp Key's slide hammer action to prevent the key getting stuck on valves.

Fire Hydrant Valve Key - 011HYD	
Dimensions (L x D)	200 x 20mm
Head Size	80mm (L) x 14mm (D)
Weight	0.8kg
Material	Cast Stainless Steel
Light Duty    Medium Duty <input checked="" type="checkbox"/> Heavy Duty	

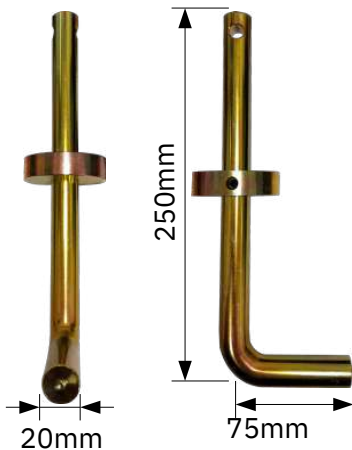

- Used with:
- Drainage
  - Gas
  - Electricity
  - Telecoms
  - Pest Control
  - Fire Service
  - Fresh Water

A 20mm hooked tip designed for use on seized gully covers, with a stopper disc that allows the user to hammer the tip into clogged gully grates and also reduces the travel of the tip allowing more force to be exerted on the cover.

20mm Gully Tip - 019GLY	
Dimensions (L x D)	250 x 75mm
Head Size	20 x 75mm Hook
Weight	1.0kg
Material	Hardened Steel
Light Duty    Medium Duty <input checked="" type="checkbox"/> Heavy Duty	

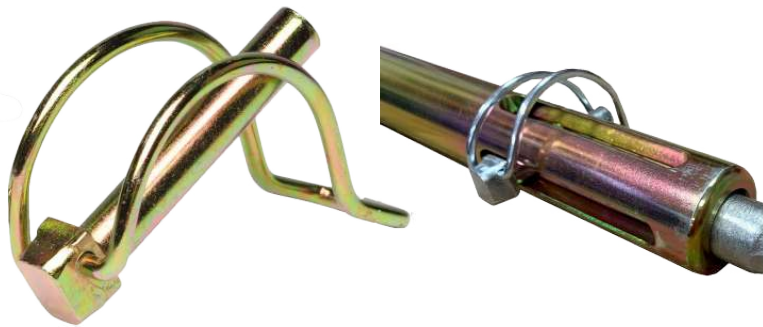

## RETAINING PIN

Linch pin used in The CoverUp Key bar to retain the tips to the tool

Each CoverUp Key set includes 2 x Retaining pins

Item Code: 015CLP



## COVERUP KEY ACCESSORY CASE

Case included with every CoverUp Key set. Tips not included with case when purchased individually

Item Code: 019CAS



# The X500

The Listening Stick for the 21st Century

**The Old    The New**



We've taken the traditional listening stick and updated it, using modern materials and digital technology.

The X500 greatly amplifies sounds generated when compared to a normal listening stick. These results are further improved by the over-the-ear headphones included with each X500.



**Headphones and carry case included with each X500**

X500 – Electronic Leak Detection	
Weight	0.7kg
Grip	Blue Acetal
Rod	1m Stainless Steel
Battery	Rechargeable Li-Ion ~6hrs operation



# SOLOPro+

## PIPELINE VIDEO INSPECTION SYSTEM

SOLOPro+ has all you need to inspect pipes, document your findings, and create detailed reports for on-site delivery. It captures detailed footage under tough conditions and its interface offers robust tools including observation entry and reporting options – and accepts USB and SD media for the easy off load of data, video, images and reports. SOLOPro+ is WiFi enabled to allow remote access to stored images and data.

Mini-Cam's SOLOPro+ push camera systems use the latest technology, are highly portable and designed for operation by only one person. The push rod is highly flexible and incredibly strong, allowing easy passage around bends, unlike other push camera available on the market today.



**CHOOSE FROM 4 ROD LENGTHS**



**120M, 100M, 60M, 40M**

SYSTEM	Video Format	PAL	
	Battery	6-hour Lithium-Ion	
	Charging	Mainspower (100-240 Vac) or vehicle power (12 or 24 VDC) using supplied adaptors	
	Display	8" TFT LCD (800x600 pixels) Sunlight Readable	
	Keyboard	Full QWERTY Style membrane keyboard with arrow keys for navigation and separate joystick for camera control	
	Video Recording	MPEG4 (WinCan Compatible)	
	Image Capture	JPEG (live or from recorded video)	
	Text overlay	16 page (selectable text and colours)	
	Internal Memory	32GB (Expandable to 128GB)	
	External media	SD HD and USB 2.0	
CCU210 CONTROLLER	Language Support	Multiple	
	Connections	Power Reel	
	Environmental Rating	IP54	
	Weight	3kg (6.6lb)	
	Dimensions	(W x H x D) 435 x 250 x 140mm	
	REEL	Construction	Welded Steel
		Finish	Powder Coated
		Controls	Friction Break
		Weight	40m 15kg, 60m 20kg, 100m 30kg
		Dimensions	40m (130') 530 x 365 x 690cm 60m (200') 690 x 370 x 890cm 100m (330') 790 x 370 x 960cm



AVAILABLE TO HIRE

# ROLLER SKIDS *SOLOPro+*

Available in 2 sizes to fit self levelling axial camera (CAM025) and the pan & rotate camera (CAM026). Manufactured from stainless steel and ABS plastic, the device is sturdy, rugged and corrosion resistant to withstand the punishment of daily field work.

	Product Code:	Description
A	ASS-002-009	180mm Roller Skid for CAM023/25
B	ASS-001-955	180mm Roller Skid for CAM026
C	ASS-002-160	130mm Roller Skid for CAM026
D	ASS-002-008	130mm Roller Skid for CAM023/25

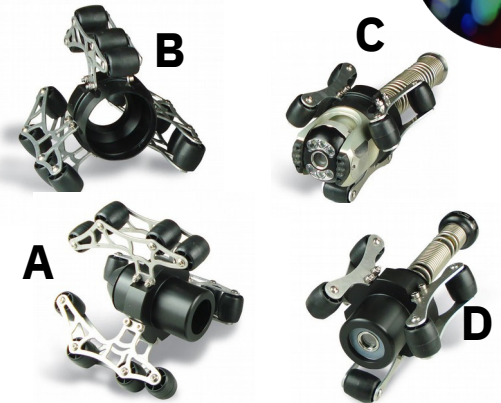

# LATERAL PIN KIT *SOLOPro+*

**A must have accessory for the smooth inspection of incoming laterals**

A useful addition to the SOLOPro+ pipeline inspection system. Used exclusively with the pan & rotate camera (CAM026), simply attach the pin to allow the inspection of incoming lateral pipe. The pin adjusts the direction and guides the camera smoothly along the pipe. The kit comes with three sizes of pin small 150mm (6in), medium 225mm (9in), large 300mm (12in), fixings and full instructions

**Product Code: ASS-001-968**



AVAILABLE TO HIRE

# TILT TABLE for *SOLOPro+*

Quick and easy to attach, the tilting table enables virtually unlimited manoeuvrability of the control unit position, to give the user customisable screen viewing and keyboard positions. The table can be tilted 35o forward and 75o backwards, with a full unobstructed 360o horizontal rotation. No tools required, the tilt table is simply attached using the adjustable clamps. TTC01 is exclusively compatible with Mini-Cam's Proteus and SOLOPro+ Control units and coiler/compatible coiler frames.



# ALL TERRAIN WHEELS *SOLOPro+*

The All Terrain Wheels attachment provides better stability for the user when rolling a coiler through rocks, grass, woodland, mud and pavement. Sturdy construction, portable and easy-to-store. Quick to attach and remove, no tools required.

**Product Code: TTC01**

**Please Note:** The All Wheels Attachment is not intended for use on stairs or kerbs.



AVAILABLE TO HIRE

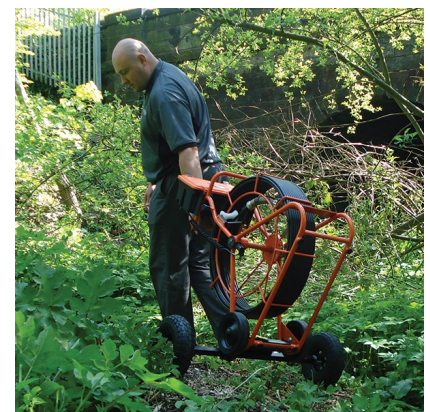



WiFi™



# PROTEUS LITE

Entry level, modular system. State-of-the-art functionality...at a very affordable price.



Mini-Cam's NEW Proteus Lite brings together, the tried and trusted performance and reliability of the Proteus family, in a value for money, entry level system. Proteus Lite is the ideal starter kit for a one-man operation, integration into a small inspection van, or a low-cost option for larger companies to use for off-road, remote locations. Proteus Lite provides all the resources required to undertake efficient, easy to perform inspections, and with ProPIPE+ and WinCan Embedded software as standard, you can deliver accurate, detailed reports, instantly on-site.

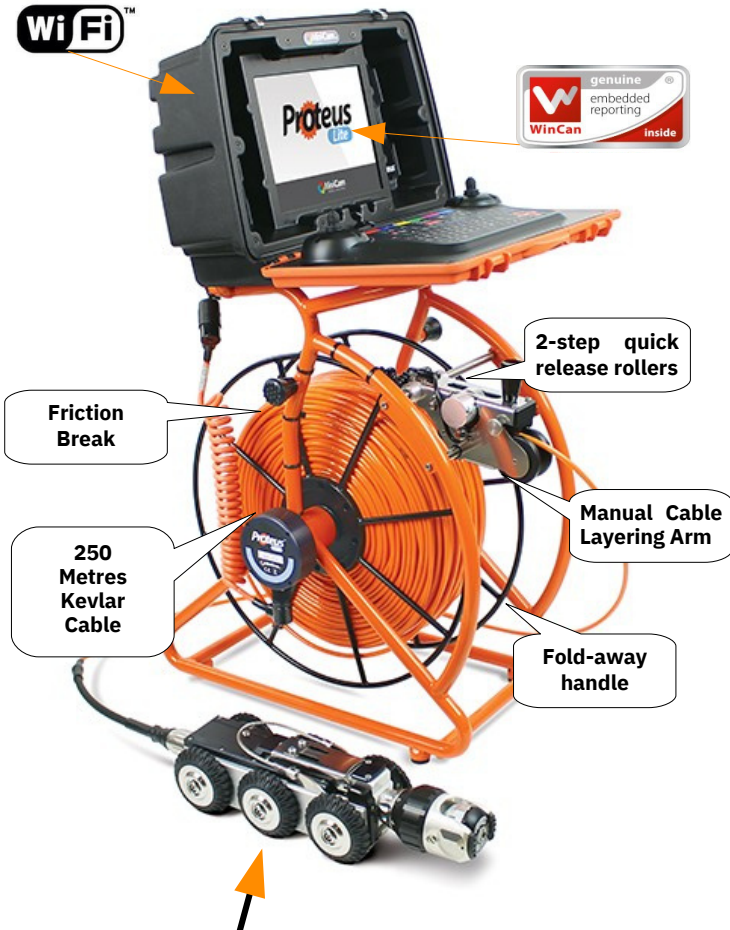

Friction Break

2-step quick release rollers

250 Metres Kevlar Cable

Manual Cable Layering Arm

Fold-away handle

## NEW CPL150 CRAWLER FOR PIPES 150MM AND LARGER

6-wheel Drive ● Steerable ● Quick-release Elevator Arm ● in-built Lowering Handle  
Camera: Full 360o Rotation ● +/-135o Pan ● Ultra-bright Dual 3 LED Cluster



The system comprises a **CCU208** Control Unit, **RMPL250** Reel and a **CPL150** Crawler.

### RMPL250 SPECIFICATIONS

Construction	Welded Steel
Finish	Powder Coated
Distance Counter Units	Feet, Metres
Controls	Friction Break
Weight	29.3kg
Dimensions (L x W x H)	550 x 385 x 700mm



### PTP04

Product Code:	PTP04
Compatibility	Proteus Lite
Dimensions (L x W x H)	680 x 1170 x 740mm
Weight Unladen	16.4kg





**RICH WITH  
MINI-CAM'S  
WORLD  
RENOWNED  
INNOVATIVE  
FEATURES**

**Proteus™**

# PIPELINE CRAWLER INSPECTION SYSTEM

A system feature rich with Mini-Cam's innovative and unique connections. Locks, devices, and Bluetooth remote controlled cable reels, provides users with probably the most versatile system on the market today. Proteus system delivers quality inspections in the most challenging environments, including ATEX Zone 2.



**AVAILABLE  
TO HIRE**

## PROTEUS CRAWLER KEY FEATURES

- Electronic Clutch
- Motorised Elevator
- In-Built Multi-Frequency Sonde
- LED Auxiliary Lights/ Backeye
- Optional Cameras
- Inclination Sensor
- Quick Release Wheel Locks
- Optional Performance Wheels
- Optional Wheel Sizes
- Flexible Heavy Duty Connector
- In-Built Lowering Device.

Motorised Cable Reel and Bluetooth Remote Control



Bluetooth®



**CONTROL UNIT**

Operating System	Linux
Screen	XGA(1024 x 768 pixels) Daylight Viewable
Interfaces	RS2 32, USB 2.0
Internal Storage	Internal Solid State
External Storage	2 x USB 2.0/ SDHC
File Format	MPEG-4/JPEG Stills
Weight	5.5kg (12.12lb)
Dimensions	L x W x H 430 x 280 x 150mm

Standard features and options vary by model visit [minicam.co.uk](http://minicam.co.uk) for full technical specifications

## THERE'S A PROTEUS CRAWLER FOR EVERY CHALLENGING ENVIRONMENT – WHICH WILL YOU DRIVE?



**CRP300**  
Perfect for pipe sizes 300-1000mm



**CPL150**  
Perfect for pipe sizes 150-600mm



**CRP140**  
Perfect for pipe sizes 150-600mm



**AVAILABLE  
TO HIRE**

**CRP90**  
Perfect for pipe sizes 90-300mm

## PROTEUS CAMERAS – OPTICAL EXCELLENCE FOR CHALLENGING ENVIRONMENTS



PAN & ROTATE ZOOM  
CAM028



PAN & ROTATE  
CAM026



AXIAL CAMERA  
CAM027



AUXILIARY LIGHT  
ALN300



AUXLIGHT/BACKEYE  
ALB300



# Proteus™ CRAWLER CRADLE

Use with Mini-Cam's CRP140 and CRP150 crawlers in large diameter pipes. Versatile, quick and easy to attach, the cradle provides extra ground coverage enabling increased inspection capabilities in pipes and culverts.

- Exclusively compatible with Proteus CRP140/150
- 4-Wheel Steerable
- Driven through crawler
- Good ground coverage
- Simple, quick installation

<b>PCC01</b>	<b>Product Code:</b>	<b>PCC01 Crawler Cradle</b>
	Compatibility	Proteus CRP140/CRP150 4-
	Drive Mechanism	Wheel-Steerable
	Power Transfer	Driven through crawler
	Dimensions	410 x 265 x 220mm (L x W x H)
	Weight	7.65kg (16.9lb)
	Wheels (Supplied)	4 x 220mm Balloon Wheels
	Optional	250mm Balloon Wheels*

\*Recommend for inspections in heavily silted pipes, and required to centralise the cradle in 1000mm pipes



# ProteusPower



No need to rely on vehicle or mains power. Mini-Cam's unique Proteus Power Pack enables pipeline inspections in the most remote locations

**Proteus Power provides compact, portable power with 5 hours inspection time... where will it take you?**

- Output short circuit protected
- LED charge status indication
- LED battery fault indication
- Proteus battery state indication
- Proteus auto power down on low
- Carry Bag (optional)

**Specification**

Output voltage	24 volts DC Nominal
Maximum output current	12A
Capacity	14Ah
Charging voltage	10-32 volts DC
Charging current	3A@ 24 volts in, 6A volts in
Average duration of fully charged battery	5 hours
Maximum charge time	7 hours





## TILT TABLE *Proteus*<sup>TM</sup>

Quick and easy to attach, the tilting table enables virtually unlimited manoeuvrability of the control unit position, to give the user customisable screen viewing and keyboard positions. The table can be tilted 35° forward and 75° backwards, with a full unobstructed 360° horizontal rotation. No tools required, the tilt table is simply attached using the adjustable clamps. TTC01 is exclusively compatible with Mini-Cam's Proteus and SOLOPro+ Control units and coiler/compatible coiler frames.

**Product Code: TTC01**



## ALL TERRAIN WHEELS *Proteus*<sup>TM</sup>

The All Terrain Wheels attachment provides better stability for the user when rolling a coiler through rocks, grass, woodland, mud and pavement. Sturdy construction, portable and easy-to-store. Quick to attach and remove, no tools required.

**Product Code: TTC01**

**Please Note:** The All Wheels Attachment is not intended for use on stairs or kerbs.

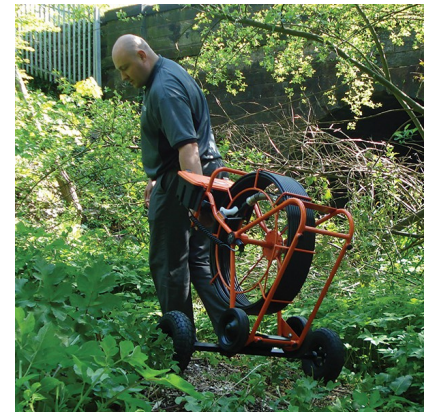

AVAILABLE TO HIRE

## *Proteus*<sup>TM</sup> COMPATIBLE COILER

Push rod coiler CCP60R (Ready) with removable self levelling camera head. Designed to plug directly into the Proteus CCU. Also available as CCP60D (Duo) allowing the Pan & Rotate camera (CAM026) supplied with the Proteus crawler to be attached. Robust construction with powder coated finish.

**Available with 60 metre or 100 metre rod lengths A –**

**Compatible coiler with Pan & Rotate Camera**  
CCP60/CAM026  
**B – Compatible Coiler with Axial Camera**  
CCP60R/CAM025

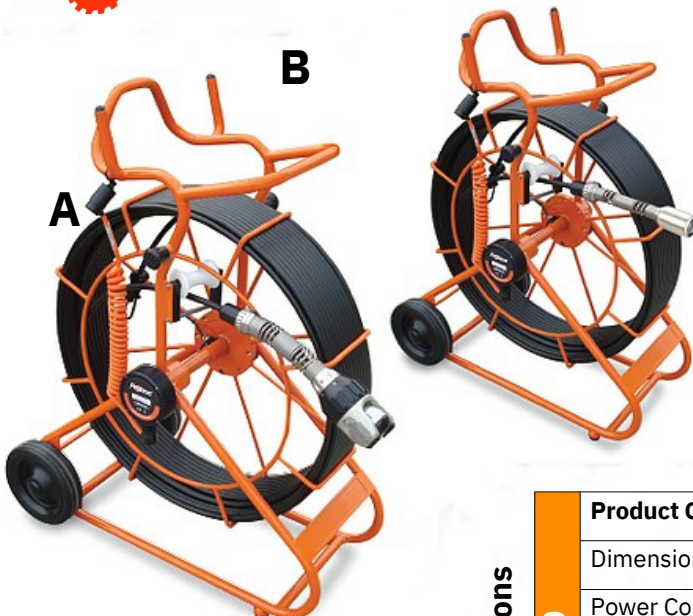

AVAILABLE TO HIRE

Specifications

CCP60

<b>Product Code:</b>	<b>CCP60 Compatible Coiler</b>
Dimensions	890 x 360 x 690mm (H x W x D)
Power Consumption	17W
Weight (without CCU)	21.35kg (47.1lb)
Temperature Range	-20oC - +50oC
Environmental Protection (Camera)	IP68
Environmental Protection (Coiler)	IP54



# MANUAL CABLE REELS

Sturdy, rugged and built to withstand harsh environments. Mini-Cam manual cable reels are compact, portable and tray easy to use. The robust powder coated frame houses are high tensile strength Kevlar reinforced inspection cable. Smooth pay-out and re-winding is performance enhances by the cable layering mechanism and durable heavy duty turning handle



The specialised crawler connector provides a waterproof seal and there's a removable drip for easy cleaning and maintenance. The reels available in 3 sizes: small 100m, mid-size 200m and large 300m reels. The small and mid-size reels can be fitted to our portable storage trolley



Cable Layering Mechanism



Cable available in ATEX Zone 2 Approved

Product Code:	RMP100	RMP200	RMP300
Dimensions (L x W x H)	530 x 220 x 520mm	530 x 280 x 520mm	530 x 400 x 520mm
Weight	18kg(40lb)	27kg (60lb)	37kg (82lb)
Cable Length	100Metres	200Metres	300Metres
Environmental Protection	Splash Proof	Splash Proof	Splash Proof

RMP



# Proteus™ MOTORISED CABLE REELS

Mini-Cam motorised cable reels are designed for easy one-person operation in remote locations. The reels are fitted with high tensile strength Kevlar reinforced inspection cable. The ultra-smooth operation is provided by the powerful three phase motor and cable layering mechanism for uninterrupted, tangle free pay-out and re-winding. A rigid, clear safety screen prevents contact with the cable whilst coiling. In the event of an emergency, the reel also features an emergency stop button. The specialised crawler connector provides a waterproof seal and there's a removable drip tray for easy cleaning and maintenance. The reel is operated using the dedicated keys and intuitive on-screen display on the Proteus Control Unit.



Cable Reel



Product Code:	RAP200	RAP300
Dimensions (L x W x H)	530 x 320 x 520mm	530 x 440 x 520mm
Weight	32.5kg(72lb)	42.5kg (94lb)
Cable Length	200metres	300metres
Power Supply	24v	24v
IP Rating	IP54	IP54

The optional hand-held 4 button, Bluetooth control allows the user to remotely operate paying-out, re-winding the crawler movement. Motorised reels are available in 2 sizes – large 300m and small 200m. The 200m reel has secure fixing points for fitting to our portable storage trolley,





# PORTABLE STORAGE TROLLEY

## COMPLETE MOBILITY FOR YOUR PROTEUS SYSTEM

Eliminate health-hazardous lifting and time consuming carrying to your remote work site. Engineered to allow for the mobile operation of your Proteus Inspection System in difficult to reach areas, such as inside buildings, or other situations a distance away from your vehicle, the trolley securely holds everything you need to efficiently undertake your pipeline inspection. Simply wheel the unit to your location, connect a camera and crawler and you're up and running in minutes, and with the added convenience of Mini-Cam's unique Proteus Power Pack, there's no need to rely on generator or mains power. The power pack enables pipeline inspection in the most remote locations with up to 5 hours inspection time.

Designed with simplicity in mind, the trolley incorporates Control Unit CCU208, Manual Cable Reel RMP200 or RMP100, Battery Pack BPP01 and Accessory Case making the whole Proteus system highly portable and suitable for one-man operation.

**Available with a choice of cable reel sizes: 200metre (RMP200) or 100metre (RMP100)**

**Trolley + Battery + Power Lead and Link Cable**



\*Equipment shown on trolley not included with PTP01

<b>PTP01</b>	<b>Product ID:</b>	<b>PTP01</b>
	Dimensions (W x H x D)	65 x 115 x 74.5cm (25.5 x 45.2 x 29.7inch)
	Weight (unladen)	9.75kg (21.5lb)

# FLOATATION RAFT

**PIPE INSPECTION IN FLOWING WATER JUST GOT EASIER!**

Eliminate the need for man-entry. The floatation raft features three extremely powerful angled auxiliary LED ultra-bright light modules to provide enough light to illuminate pipes in excess of 2000mm. Small enough to be lowered down most common sizes of manhole cover, the compact design allows inspection capabilities in pipes from 600mm.

Designed and manufactured in-house to exacting standards, the tough polyethylene construction of the raft body is impact resistant and designed to withstand challenging inspections. An in-built lowering loop makes for quick and easy deployment and retrieval, and the factory tested floatation plate ensures the device is perfectly balanced to eliminate rolling.

\*Additional software may be required

- A **Auxiliary Lights**
- B **Floatation Plate**
- C **Strain Relief**

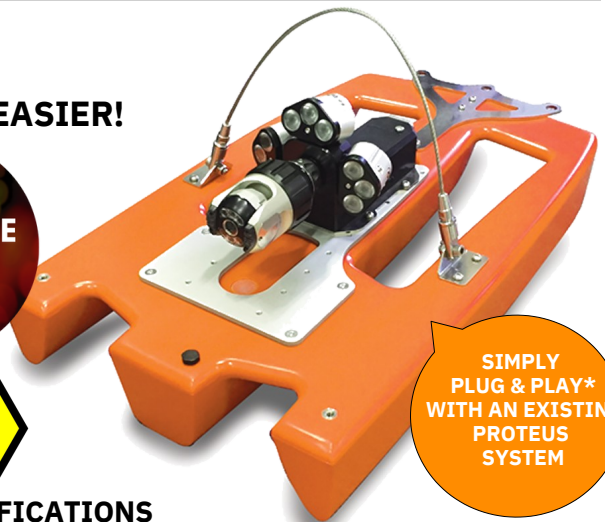

**SIMPLY PLUG & PLAY\* WITH AN EXISTING PROTEUS SYSTEM**

### SPECIFICATIONS

<b>FRP01</b>	<b>Product Code:</b>	<b>FRP01</b>
	Dimensions (L x W x H)	680 x 420 x 200mm
	Weight (without camera)	5.8kg (12.7lb)
	IP Rating	IP68





Mini-Cam's Unique Patented Quick Change Wheel Lock

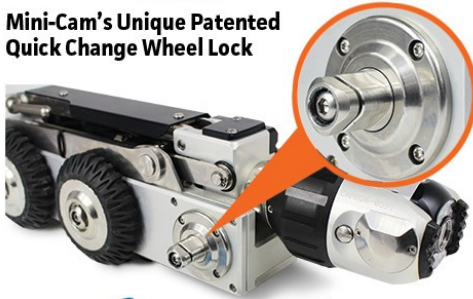

# CRAWLER WHEELS **Proteus**<sup>TM</sup>

SPECIALY DESIGNED WHEELS OFFER PERFORMANCE BENEFITS FOR VARIOUS PIPE DIAMETERS AND SPECIFIC CONDITIONS



## WIDE AXLE WHEELS

Extend the capability of your crawler. Quick and easy to attach, wide Axle wheels provide instant extra width for inspections in wider pipe Diameters. Available in Soft Black Rubber, Carbide and High Grip



Proteus crawlers feature Mini-Cam's unique patented wheel lock device, making it easy to adapt the crawler wheel type to suit the size and condition of the pipe. Using the supplied 4mm T bar the operation is quick and simple with no other tools required

### SOFTBLACK RUBBER

Rich black, soft rubber tyres developed to provide improved traction in regular pipes.

Available in 3 sizes and Wide Axle

IMPROVED TRACTION



### CARBIDE

Fragmented copper particles fused to a heavy duty stainless steel body.

Available in 3 sizes and Wide Axle

FOR PLASTIC PIPES



### PNEUMATIC BALLOON

Heavy duty, 250mm wide tyres designed to improve performance on our large Proteus CRP300 crawler.

Available in 1 size and Wide Axle

RUGGED HEAVY DUTY



### HIGH GRIP WHEELS

Hard wearing carborundum manufactured with a deep bevel profile to provide improved traction in wet and greasy pipes.

Available in 3 sizes and Wide Axle

FOR WET & GREASY PIPES





## SOLOPRO+ MINI REEL

# SOLOPro+

AVAILABLE  
TO HIRE

Designed to inspect smaller diameter pipes in confined spaces, Minicam's SoloPRO+ Mini Reel is suitable for use in pipes as small as DN32.

Thanks to its unique design and highly flexible spring, the Mini Reel provides a unique solution for those surveying small diameter pipes.

### Excellent Picture Quality

The 30mm camera head with ultra-bright LEDs, and generous 390mm spring length, enables unlimited adaptability for hard to navigate situations.

### Ultra-flexible

Boasts an impressive 390mm length of ultra flexible spring which enables unlimited adaptability for those hard to navigate, awkward situations.

### Small Diameter

Specially designed for inspections in pipe diameters as small as 32mm, ideal for domestic plumbing and hard to reach traps.

### Built-in Sonde

This unit includes a built-in sonde that transmits at 512Hz or 640Hz.

### Quick Release Basket

The unique release clip makes interchanging the mini coiler basket quick and easy, with no tools required.

### Easy-fit Control Unit

Minicam's unique cow-horn shaped CCU locator makes for a secure quick fit, ready for work.

***\*please note that the SoloPRO+ CCU is sold separately***



## M18™ Inspection Camera



- 1080p camera with pan zoom
- Several LEDs in cam head deliver excellent images
- Fully enclosed reel for less mess
- In-built sonde transmits at 512Hz, 640Hz and 33kHz and works with all major locators
- Available with a 36m or 60m reel
- Milwaukee's ONE-KEY system for enhanced security

## M12™ Handheld Inspection Camera Kit



- Removable screen provides an excellent image and allows users to easily manoeuvre the camera whilst maintaining sight of the screen
- 4 x zoom and screen rotation
- 3m long inspection cable
- Aluminium head and enhanced cable makes this a durable and manoeuvrable device
- Comes with a 2.0AH battery and charger

## M12™ Pipeline Locator



- 2 omnidirectional antennas make the M12 Locator incredibly easy to use
- 4.3 inch colour LCD screen
- Will operate for 13 hours with a fully charged M12 2.0Ah battery
- Display shows an arrow that points in the direction of sondes and a compass that directs users along the path of energised lines
- Has IP65 rated protection and can be used in challenging conditions

## MX FUEL™ Saw



- Battery-powered, but just as powerful as it's petrol-powered equivalents, Milwaukee's MX Fuel Cut-Off Saw can cut through reinforced concrete.
- Free access to Milwaukee's cloud-based tracking network ONE-KEY for improved inventory management and security.

## MX FUEL™ 28mm Hex Demolition Hammer



- A completely cordless demolition hammer from Milwaukee
- 64 blow Joules of impact energy
- Anti-vibration technology allows operatives to work longer
- Petrol-powered performance from a battery-powered hammer

## MX FUEL™ Large Sewer Drum Machine



- Clears roots and other tough blockages in pipes of between 75 and 200mm
- POWERREDZ™ technology makes it easy for one person to transport
- Can clear blockages at a depth off up to 60m
- Enclosed drum and lack of free spinning parts make this safe and minimises mess
- Electronic foot pedal for maximum control and enhanced safety
- Petrol-powered performance with the convenience of cordless battery power

## M18 FUEL™ Handheld Drain Cleaner



AVAILABLE TO HIRE

- Clears roots and other tough blockages in pipes of between 75 and 200mm
- POWERREDZ™ technology makes it easy for one person to transport
- Can clear blockages at a depth off up to 60m
- Enclosed drum and lack of free spinning parts make this safe and minimises mess
- Electronic foot pedal for maximum control and enhanced safety
- Petrol-powered performance with the convenience of cordless battery power

## M12™ Handheld Sub Compact Drain Cleaner



- Lightest professional drain cleaner currently available
- Versatile design provides the benefits of handheld and floor-based drain cleaners
- Works in up to 50mm pipes and can be used with 6 and 8mm spirals
- Milwaukee's REDLINK technology protects electronics for best in-class durability

## M18 FUEL™ Free Standing Drain Cleaner



- The world's first free standing drum machine using an 18v battery
- Suitable for 32 to 75mm pipes
- Electronic foot pedal provides users with maximum control and safety
- Enclosed drum reduces the risk of injury and mess
- Operatives can rapidly interchange between cable sizes or add a second drum doubling the operational range to 30m

## M18 FUEL™ Compact Sectional Sewer Machine



- World's first compact sectional sewer machine using an 18v battery with 16 and 22mm sectional spirals
- Weighs just 14kgs (battery included) making it easy to transport
- Can be used in pipes between 32 and 160mm and has an operational range of 46m
- Compact design means this device can easily be used in tight spaces

## M12 Stick Transfer Pump



- Pumps 34 litres of water per minute
- Ideal for emptying trenches, storm drains, outside meter boxes, rain barrels and more
- Unique HYDROPASS filter system protects inlet
- Maximum head height of 4.5m
- Submersible up to 85cm

## M18 Compact Transfer Pump



- Pumps 1,817 litres every hour
- Can transfer 908 litres of water with one fully charged M18 5.0Ah battery
- Pump automatically shuts off when it stops moving water
- Powerful motor generates a lift height of 5.5m and a head height of up to 23m

AVAILABLE  
TO HIRE

## M18 FUEL Air Compressor



- Provides sufficient power to run common finish nailers and staplers
- At only 68 dB(A) this is one of the quietest cordless compressors on the market allowing for a more comfortable working environment on the jobsite
- Easy to transport thanks to low weight (14kg) and two carry handles
- Single turn regulator allows quick and easy adjustment of the pressure to the desired level

## Lighting Solutions

### M18 Stand Light



- 2,000 lumens from 12 high-performance LEDs
- Adjustable head is impact resistant and houses highly durable polycarbonate lenses
- Head can be rotated 230° vertically and pivoted 240° horizontally
- Protective guard secures head and lenses whilst light is collapsed
- Mast reaches from 1.10 to 2.20 metres
- Dust and splash proof

### M18 Tradesman Area Light



- Up to 2,200 lumens
- Advanced LED technology for 360° of area light and 90° of task lighting
- Easy to transport with just one hand
- Impact and chemical resistant lenses
- Metal hook for overhead hanging

### M18 PAL-0 Area Light



- Up to 1,500 lumens and up to 20 hours of run time
- Multiple mounting options thanks to 2 magnets, a spring-loaded clamp and folding rotating light head
- Durable and impact-resistant lenses can withstand falls from heights of up to 2.7 metres
- Dust and splash proof

## Batteries and Chargers

### M12 & M18 Fast Battery Charger



Charges REDLITHIUM™ HIGH OUTPUT™ batteries up to 4x faster vs standard charger meaning reduced downtime and maximising productivity. Fully charges the M18™ HIGH OUTPUT™ 12.0 Ah battery in 60 min, the 8.0 Ah in 45 min and the 5.5 Ah in 35 min.

### M18 12.0AH High Output Battery



The new M18™ 12.0 Ah HIGH OUTPUT™ battery pack provides up to 50% more power vs M18™ REDLITHIUM™ battery packs. Patented REDLINK™ intelligence also protects the pack from tough jobsite conditions to ensure optimum performance.

### M18 8.0AH Battery



The new M18™ 8.0 Ah HIGH OUTPUT™ battery pack provides up to 50% more power vs M18™ REDLITHIUM™ battery packs. Patented REDLINK™ intelligence also protects the pack from tough jobsite conditions to ensure optimum performance.

### M18 5.0AH Battery



Delivers up to 2.5x more run time, up to 20% more power and up to 2x more battery life compared with other Lithium-Ion technologies and / or with previous MILWAUKEE® battery technology. (Results depend on tool and application).

### M12 6.0AH Battery



Delivers up to 3x more run time, up to 20% more power and up to 2x more battery life compared with other Lithium-Ion technologies and/or with previous MILWAUKEE® battery technology (Results depend on tool and application).

### M12 2.0AH Battery



Up to 2X more run time\*, 20% more power\*. Up to 2X more recharges and compared with other Lithium -Ion technologies and / or with previous MILWAUKEE® battery technology. Results dependant on voltage, tool and application.



## Milwaukee High Speed Flexible Shaft Machine



**£2,450 without bundle  
or  
£2,850 with bundle\***

\*bundle includes 4 standard chains (32-40mm, 50mm, 75mm and 110mm), 500ml of lubricating oil, 2 x 12Ah batteries, and a fast charger.

**AVAILABLE  
TO HIRE**

- Milwaukee's M18 High Speed Flexible Shaft Machine is perfect for clearing blockages from and restoring pipes to optimum condition.
- This powerful cleaner can be used in pipes of between 32mm and 110mm and has a range of 23 metres.
- Variable speeds of between 600 and 2,000 RPM, an electronic foot pedal and integrated drum brake provide the user with maximum control as well as improving safety.
- The 8mm nylon coated cable with universal reception fits most common attachment heads currently available.
- All terrain wheels and an extendable telescopic handle make it easy to transport this machine from one location to another.
- Possesses a highly durable outer frame and cables that can easily be repaired or replaced whilst in the field.

# GAS CAMERA PUSHROD



## Gas Pushrod

- 80 metres of 7.2mm rod
- Sturdy stainless steel frame
- 10 metre link lead with rugged stainless steel connectors Designed to be operated in all weather conditions
- 120m of 9mm rod version available

## Hippo 400 Control Unit

- 8" high bright, daylight viewable screen
- Built in SD video recorder with pause on record and screen shot functionality
- Built in batteries giving over 5 hrs of continuous operation
- Battery charging from 240/110V mains or 12V in car charger



## 31F Camera

- Fixed 30mm camera head
- Can be inserted into smaller tapping holes from 1 1/4" Hi-brightness LED's
- Wide angle view, providing easy identification of tapping points

## 47SR Camera

- 47mm, self-levelling camera head
- Outstanding picture quality
- Adjustable hi-brightness LED's
- Camera design reduces light reflection from the pipe walls



### WASK Camera Launch Tube

- Approved for use on live gas mains
- Corrosion resistant steel construction
- Hardened tip on entry tube for longer life

# DCR's DRAIN DYE

## Highly concentrated drain dye



Available in red, green, blue or orange, each 200 gram tub of our drain dye can colour 20,000 litres of water. Also available in 5kg tubs.



## Single Shot Drain Dye Dispenser



Available in orange and green or red and blue, our single shot dye dispensers allow operatives to dispense a controlled amount of dye with each use, avoiding unnecessary waste.

## About The Maxi Miller

Suitable for drain cleaning, root clearing, later re-instatements, collapsed liner removal and more, the Picote Maxi Miller is a powerful multi-functional and very durable machine with a 30m/100ft range. For DN100 - 250 / 4" - 10" pipes.

May require generator

### Features

- 30m/100ft of 12mm / ½" shaft with thick outer casing.
- Suitable for drain cleaning & powering the Smart Cutter™, Twister, Collapsed Liner Twister and the Pipe Cutter.
- Suitable for the new Smart Spider.
- For DN100 - DN200 / 4" - 8" pipes.
- Weighs 95kg / 210 lbs
- 1400rpm, 1130w output.
- Electric motor & safety clutch.



## About The Super Midi Miller

The Super Midi Miller replaces the older Midi Miller with powerful upgrades for drain cleaning and reinstatement from DN70/3" to DN150/6". The Super Midi has an electric safety clutch. It comes with the same powerful control box as Picote's Maxi Miller and Maxi Power+.

In addition to increased efficiency and safety, the Super Midi has a 20m / 65ft range with the option of adding a 10m / 32ft extension.

### Features

- Excellent combination of safety, force & movability.
- 20m / 65ft range with an option to add a 10m / 32ft extension.
- A multi-use machine for heavy descaling, pipe cleaning & reinstatements.
- Ideal for work inside buildings: Regular outer casing for 12mm/½" shaft allows added flexibility through bends.
- Run the 110v/16amp UK model from a house connection in the UK with the use of a transformer.



## About The Mini Miller

The Mini Miller is a high-speed and high torque machine designed for cleaning, descaling and removing roots in DN50 to DN100 / 2" to 4" pipes. Suitable for reinstatements inside DN50 to DN100 / 2" and 3" pipes. Add the Mini Pump to brush coat DN50 to DN150 / 2" to 6" pipes.

**AVAILABLE TO HIRE**



### Features

- High speed drain cleaning.
- Blockage removal.
- Fast reinstatements through DN50, DN70 & DN100/2", 3" & 4" P-Traps.

All service and repairs carries out by DCR Inspection Systems Ltd

## Picote Twisters

### Twister



For reinstatements inside clay, cast iron, concrete and plastic pipes. Brushes keep the twister centred in the pipe. All sizes come with a spare 3mm front metal panel. All for 12mm shafts.

Variations:

- DN100 for lined pipe - **1230075100Y**
- DN100 for unlined pipe - **12320085100Y**
- DN150 for lined pipe - **1230115150Y**
- DN150 for unlined pipe - **1231125150Y**
- DN200 - **123017500Y**

### Tiger Twister Liner & Concrete Remover

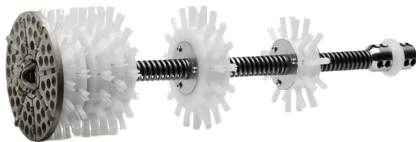

Remove failed CIPP lining twice as fast as with a regular twister or remove concrete.

Variations:

- DN100 for lined pipe - **1263075100**
- DN100 for unlined pipe - **1263085100**
- DN150 for lined pipe - **1263115150**
- DN150 for unlined pipe - **1263125150**

### Twister Concrete Remover



Picote's Twister Concrete Remover feature dual front brushes to improve stability. A heavy duty front panel featuring large carbides is complemented by a specialised front drill head with star carbides. Combined, these elements provide a highly efficient tool for clearing concrete, grout, slurry and rocks.

Variations:

- DN100 for 12mm shaft - **1234085100**
- DN150 for 12mm shaft - **1234125150**
- DN100 with Steering Axle for 12mm shaft - **1234085100SA**
- DN150 with Steering Axle for 12mm Shaft - **1234125150SA**

### Twister Liner Remover



Two front brushes aid stability whilst the custom-built flat drill head and 3mm front metal panel with aggressive carbides ensure rapid liner removal in cast iron and concrete pipes.

Variations:

DN100 for lined pipe - **1233075100**

DN100 for unlined pipe - **1233085100**

DN150 for lined pipe - **1231115150Y**

DN150 for unlined pipe - **1230125150Y**

### Twister Express



Picote's fastest option for reinstating lined connections in cast iron, clay, concrete or PVC pipes

Variations:

DN50 for 8mm shaft - **1230000052**

DN70 for 8mm shaft - **1230000072**

DN70 for unlined pipe and 12mm shaft - **1230000371**

DN 70 for lined pipe and 12mm shaft - **1230000471**

DN100 for lined pipe and 12mm shaft - **1233075102**

DN100 for unlined pipe and 12mm shaft - **1233085102**

### Twister Mini Flexi



Picote's Twister Mini Flexi allows operators to rapidly open lateral connections, even through difficult arrangements featuring multiple bends or P-traps.

Variations:

DN50 for 8mm shaft - **1230000053**

DN70 for 8mm shaft - **1230000073**

## Picote Attachments



### Twister Concrete Remover Front Drill Head - 1300215040

For use with Twister Concrete Remover with Front Metal Panels



### Front Drill Head 4 Flat Twister Liner Remover 40mm - 1300214040

For use with Twister Liner Removers with Front Metal Panels



### Tiger Front Drill Head 38mm - 1260010038

Can be used with any Twister or Smart Cutter



### Front Drill Head 3 Ridged Hardened 35mm - 1300212035

For use with Twisters with Front Metal Panels. Also suitable for use with smart cutters with Front Metal or Front Plastic Panels

### Front Plastic Panel



Sold in packs of 10, Picote's front plastic panels provide a gentle solution when working with fragile pipes

Available in 55mm (**1229990055**), 75mm (**122990075**), 85mm (**1229990085**) and 125mm (**1229990125**)

### Tiger Front Metal Panel



Precision manufactured milling plate equipped with the specially hardened Tiger carbides. For use with Picote's Twisters and Smart Cutters

Available in 58mm for DN70 (**1260000058**), 75mm for DN100 (**1260000075**), 85mm for DN100 (**1260000085**), 90mm for DN125 (**1260000090**), 100mm for DN125 (**1260000100**), 115mm for DN150 (**1260000115**), 125mm for DN150 (**1260000125**) and 175mm for DN200 (**1260000175**)

### Front Metal Panel Twister Concrete Remover



3mm Front Metal Panel for Twister Concrete Remover with larger carbides

Available in 75mm (**1210510075**), 85mm (**1210510085**), 95mm (**1210510095**), 115mm (**1210510115**) and 125mm (**1210510125**)

### Front Metal Panel Twister Liner Remover



3mm Front Metal Panel for Twister Liner Remover with larger carbides

Available in 75mm (**1210410075**), 85mm (**1210410085**), 115mm (**1210410115**), 125mm (**1210410125**) and 175mm (**1210410175**)

### Front Metal Panel



1mm Front Metal Panel. Flexibility combined with carbides at the rear of the panel provide an advantage in reinstatement situations where the panel gets stuck.

Available in 55mm (**1210310055**), 75mm (**1210310075**), 85mm (**121031085**), 115mm (**1210310115**), 125mm (**1210310125**) and 175mm (**1210310175**)

### Front Drill Head



Spare front drill head for Picote's Twister Express

Available for DN100 lined (**1300214075**) and DN100 unlined (**1300214085**)

### Front Drill Head Kit for Twister Express



For the Twister Express and Twister Mini Flex. This replacement Front Drill Head Kit includes a Front Drill head and front brushes.

Available for DN50 (**1230000053**), DN70 (**1230000073**), DN70 unlined (for Twister Express only (**900000987**)) and DN70 lined (for Twister Express only (**900000988**))

### Polishing Panels

Sold in packages of 12, these panels are suitable for removing slight liner inconsistencies and polishing.

Available in 50mm x 100mm (**1241050100**), 75mm x 100mm (**1241075100**), 100mm x 125mm (**1241100125**), 100mm x 150mm (**1241100150**) and 150mm x 200mm (**124150200**)

### Cleaning Panels

Sold in packs of 12, these small, no wedge polishing panels are to be used with the Picote Mini Cleaner.

Available in 35mm x 45mm (**1241035045**) and 40mm x 50mm (**1241040050**)

### Side Grinding Panels

Side grinding panel for use with Picote's wedge and non-wedge hubs. All sold in packages of 12 panels.

Available in 40mm x 60mm (no wedge (**1202040060**)), 50mm x 100mm (no wedge (**1202050100**)), 50mm x 100mm (**1203050100**), 75mm x 125mm (**1202075125**), 100mm x 100mm (**1202100100**), 100mm x 150mm (**1202100150**), 150mm x 150mm (**1202150150**), 150mm x 200mm (**1202150200**), 150mm x 250mm (**1202150250**) and 200mm x 300mm (**1202200300**)

### XT Rough Side Grinding Panels

Picote's XT Rough Panels have larger grit for more aggression and faster results.

Available in 50mm x 100mm (no wedge (**1204050100**)), 50mm x 100mm (**1205050100**), 75mm x 125mm (**1203075125**), 100mm x 100mm (**1203100100**), 100mm x 150mm (**1203100150**), 150mm x 150mm (**1203150150**), 150mm x 200mm (**1203150200**), 150mm x 250mm (**1203150250**) and 200mm x 300mm (**1203200300**)

### Wire Hooks

When attached to a shaft, the wire hook can be used for pulling and guiding.

Available for 12mm shaft (**1350000125**) and 8mm (**1350000085**)

### 100 Metre Steering Wire - 1350150405

Can be used with Picote's weights for fine tuning or with the Twister Concrete Remover where there is access at both ends. Requires Picote's Steering Axle.



**Hub Weight**

A fine-tuning tool used to pull hubs downwards to remove the bottom lip of liners.

Available in small (40 (**1100500040**)) and large (60 (**1100500060**))



**Smart Steering Guide with Bearing**

A precision fine-tuning tool that attaches to Picote's Smart Cutter Hub allowing the user to steer the Hub without damaging the lined pipe during the reinstatement process.

Available for DN100-150 (**1312024125**) and DN150-200 (**1312025125**)



**Bearing for Steering Axle - 1100200001**

For use with Picote's steering axle



**Steering Axle - 1100100055**

For fine-tuning or steering tools



**Screws for Hub Discs - 1350000100**

Package of 12 spare screws for use with Picote's hub discs.



**Smart Cutter Hub Discs**

Package of 12 spare screws for use with Picote's hub discs.

Available in 2 panel 20mm diameter (**1000200020**), 4 panel 35mm diameter (**1000200035**), 4 panel 40mm diameter (**1000200040**) and 50mm diameter (**1000200050**)



**Steering Hub Discs**

For use with Picote's Steering Axle

Available in 4 panel 35mm diameter (**1000210035**) and 4 panel 40mm diameter (**1000210040**)





### Smart Cutter Hubs - No Wedge

For use with side grinding panels without wedges

Variations:

- 12x25 for DN32 - 6mm shaft (**1000612025**)
- 15x25 for DN32 - 6mm shaft (**1000615025**)
- 15x30 for DN32 - 6mm shaft (**1000615030**)
- 18x25 for DN32-40 - 8mm shaft (**1000818025**)
- 20x40 for DN50 - 8mm shaft (**1000820040**)
- 20x60 for DN50-70 - 8mm shaft (**1000820060**)
- 20x40 for DN50 - 10mm shaft (**1001020040**)
- 20x60 for DN50-70 - 10mm shaft (**1001020060**)



### Smart Cutter Hubs

For use with side grinding panels with wedges

Variations:

- 20x50 for DN70 - 8mm shaft (**1000820050**)
- 20x75 for DN100 - 8mm shaft (**1000820075**)
- 20x50 for DN70 - 10mm shaft (**1001020050**)
- 20x75 for DN100 - 10mm shaft (**1001020075**)
- 35x50 for DN70-100 - 8mm shaft (**1000835050A**)
- 35x50 for DN70-100 - 10mm shaft (**1001035050A**)
- 35x50 for DN70-100 - 12mm shaft (**1001235050A**)
- 35x75 for DN100 - 12mm shaft (**1001235075A**)
- 40x100 for DN100-150 - 12mm shaft (**1001240100A**)
- 40x150 for DN150-200 - 12mm shaft (**1001240150A**)
- 40x200 for DN200 - 12mm shaft (**1001240200A**)
- 50x100 for DN100-150 (6 panel) - 12mm shaft (**1001250100A**)
- 40x200 for DN150-200 (6 Panel) - 12mm shaft (**1001250150A**)



### Tiger Bore

Picote's Tiger Bore attachments are highly efficient at reinstating lined connections and opening up blockages. They can also be used to cut through collapsed liners to make room for larger removal tools, as well as removing grout and concrete. Tiger carbides ensure maximum working efficiency, durability and power

Available in 30mm for DN50 for 8mm shaft (**1261084030**), 40mm for DN50-70 for 8mm shaft (**1261084040**), 30mm for DN70 with 10mm shaft (**126100030**), 50mm for DN70-100 with 10mm shaft (**1261010050**), 30mm for DN70 with 12mm shaft (**1261125030**), 40mm for DN70 with 12mm shaft (**1261125040**), and 50mm for DN70-100 with 12mm shaft (**1261125050**)

### Special Drill Heads



Picote's Special Drill Head is an aggressive and highly efficient tool for reinstating lined connections. They're also good for both unblocking and removing tree roots.

Available in 4-prong 20x40 for 8mm shaft (**1300820040**), 4-prong 30x50 for 8mm shaft (**1300830050**), 4-prong 30x50 for 12mm shaft (**1301230050**), 4-prong 40x60 for 12mm shaft (**1301240060**), 4-prong 50x80 for 12mm shaft (**1301250080**), 6-prong 20x40 for 8mm shaft (**1300820240**), 6-prong 30x50 for 8mm shaft (**1300830250**), 6-prong 30x50 for 12mm shaft (**1301230250**), 6-prong 40x60 for 12mm shaft (**1301240260**), and 6-prong 50x80 for 12mm shaft (**1301250280**)

### Special 3D Drill Heads



With reverse angled cutting edges, Picote's 3D drill heads can be pulled backwards to enlarge openings made by smaller drill heads

Available in DN50-75 for 8mm shaft (**1310823055**), DN70-75 for 12mm shaft (**1311223055**), DN70-75 for 12mm shaft (with larger diameter and length (**1311224071**)), and DN75-100 for 12mm shaft (**1311225091**)

### Special 3D Drill Heads



Picote's PVC drill heads have a safety ring enabling them to safely operate inside PVC and clay pipes as well as make the initial cut within these materials

Available in DN32-40 for 8mm shaft (**1310812029**), DN50 for 8mm shaft (**1310812042**), DN50-75 for 8mm shaft (**1310813055**), DN70-75 for 10mm shaft (**1311013055**), DN70-75 for 10mm shaft (with larger diameter and length (**1311014071**)), DN75-100 for 10mm shaft (**1311015091**), DN70-75 for 12mm shaft (**1311213055**), DN70-75 for 12mm shaft (with larger diameter and length (**1311214071**)), and DN75-100 for 12mm shaft (**1311215091**)

### Special Cutter Drill Heads



Picote's Special Drill Head Cutter has been designed for initial liner opening and clearing blockages in cast iron pipes

Available in DN32-40 for 8mm shaft (**1310820029**), DN50 for 8mm shaft (**1310820042**), DN50-75 for 8mm shaft (**1310830055**), DN70-75 for 12mm shaft (**1311230055**), DN70-75 for 12mm shaft (larger diameter & length (**1311240071**)), and DN75-100 for 12mm shaft (**1311250091**)

### Special Cutter 2.0 Drill Heads



Picote's Special Drill Head Cutter 2.0 has the same features as the standard cutter but is better suited to cutting through softer materials.

Available in DN50-75 for 8mm shaft (**1310833055**), DN70-75 for 12mm shaft (**1311233055**), DN70-100 for 12mm shaft (**131134071**) and DN70-100 for 12mm shaft (larger diameter and length (**1311235091**))



### PVC Tiger Drill Chain

Picote's PVC Tiger Drill chains include an integrated front drill featuring long lasting carbides to efficiently and safely cut through roots, scale and blockages in PVC and fragile pipes

Available in DN75 for 8mm shaft (**1382084070P**), DN100 for 8mm shaft (**1382084100P**), DN75 for 10mm shaft (**1382105070P**), DN100 for 10mm shaft (**1382105100P**), DN150 for 10mm shaft (**1382105150P**), DN75 for 12mm shaft (**1382125070P**), DN100 for 12mm shaft (**1382125100P**) and DN150 for 12mm shaft (**1382125150P**)

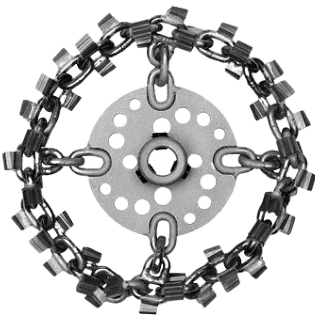

### Tiger Cyclone Chain

Picote's Tiger Cyclone Chains are lightweight and feature long lasting carbide teeth. With centrifugal force keeping the chain level and minimising damage to the pipe, they provide an excellent solution for those looking to clear blockages in cast iron pipes

Available in DN75 for 8mm shaft (**1381084075V**), DN100 for 8mm shaft (**1381084100V**), DN150 for 8mm shaft (**1381084150V**), DN75 for 10mm shaft (**1381105075V**), DN100 for 10mm shaft (**1381105100V**), DN150 for 10mm shaft (**1381105150V**), DN200 for 10mm shaft (**1381105200V**), DN75 for 12mm shaft (**1381125075V**), DN100 for 12mm shaft (**1381125100V**), DN150 for 12mm shaft (**1381125150V**), DN200 for 12mm shaft (**1381125200V**) and DN250 for 12mm shaft (**1381125250V**)

### Tiger Drill Chain

An original tiger drill chain with an integrated front drill head featuring long lasting carbides to cut through roots and lightly collapsed liners



Available in DN75 for 8mm shaft (**1380084070VP**), DN100 for 8mm shaft (**1380084100VP**), DN75 for 10mm shaft (**1380105070VP**), DN100 for 10mm shaft (**1380105100VP**), DN150 for 10mm shaft (**138005150VP**), DN200 for 10mm shaft (**1380105200VP**), DN75 for 12mm shaft (**1380125070VP**), DN100 for 12mm shaft (**138012510VP**), DN150 for 12mm shaft (**1380125150VP**), DN200 for 12mm shaft (**1380125200VP**), and DN225-250 for 12mm shaft (**1380125250VP**)

### 3D PVC Chains

By controlling the speed, operatives can allow this chain to expand gradually whilst removing blockages. This speeds up clearances and also makes it easier to navigate diameter transitions

Available in DN50-70 for 8mm shaft (**1382005070P**), DN70-100 for 8mm shaft (**1382070100P**) and DN70-100 for 12mm shaft (**138307100P**)



### 3D Premium Chains

Picote's 3D chain expands as it removes material, continuing to do so until reaching its maximum size. This allows it to navigate transitions in the diameter of piping. It also includes carbides for highly efficient cleaning

Available in DN50-70 for 8mm shaft (**1382005070**), DN70-100 for 8mm shaft (**1382070100**), DN70-100 for 12mm shaft (**1383070100**) and DN100-150 for 2mm shaft (**1383100150**)





### Spare Chains for 3D Chain

Spare chains for Picote's 3D chains

Available in DN50-70 for 8mm shaft (**1380084050D**), DN70-100 for 8mm Shaft (**1380084070D**), DN70-100 for 12mm shaft (**1380125070D**) and DN100-150 for 12mm shaft (**1380125100D**)

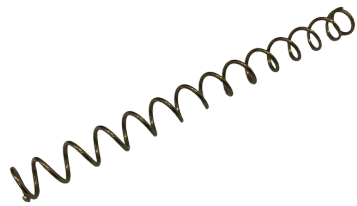

### Spare Springs for 3D Chain

Spare springs for Picote's 3D Chain

Available in DN50-70 for 8mm shaft (**9380000054**), DN70-100 for 8mm shaft (**9380000055**), DN70-100 for 12mm shaft (**9380000056**) and DN100-150 for 12mm shaft (**9380000057**)



### Spare Leaders for 3D Chain

Spare leader for Picote's 3D Premium Chain

Available in DN50-70 for 8mm shaft (**1382005071**), DN70-100 for 8mm shaft (**1382070101**), DN70-100 for 12mm shaft (**1383070101**) and DN100-150 for 12mm shaft (**1383100151**)



### Spare Chains for the 3D PVC Chain

Spare chain for 3D PVC Chain

Available in DN50-70 for 8mm shaft (**1380084050DP**), DN70-100 for 8mm shaft (**1380084070DP**) and DN70-100 for 12mm shaft (**1380125070DP**)

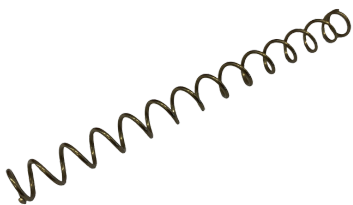

### Spare Springs for the 3D PVC Chain

Spare springs for Picote's 3D PVC Chain

Available in DN50-70 for 8mm shaft (**9380000058**), DN70-100 for 8mm shaft (**9380000059**) and DN70-100 for 12mm shaft (**9380000070**)



### Spare Leaders for the 3D PVC Chain

Spare leaders for Picote's 3D PVC Chain

Available in DN50-70 for 8mm shaft (**138200571P**), DN70-100 for 8mm shaft (**1382070101P**) and DN70-100 for 12mm shaft (**1383070101P**)

### Cyclone PVC Chains

This chain contains no carbides and self centres. It is suitable for clearing blockages in pipes made of fragile materials such as copper, plastic and clay



Available in DN70 for 8mm shaft (**1381084070P**), DN100 for 8mm shaft (**1381084100P**), DN125 for 8mm shaft (**1381084125P**), DN70 for 10mm shaft (**1381105070P**), DN100 for 10mm shaft (**1381105100P**), DN125 for 10mm shaft (**1381105125P**), DN150 for 10mm shaft (**1381105150P**), DN70 for 12mm shaft (**1381125070P**), DN100 for 12mm shaft (**1381125100P**), DN125 for 12mm shaft (**1381125125P**), DN150 for 12mm shaft (**1381125150P**), and DN200 for 12mm shaft (**1381125200P**)

### Cyclone Standard Chains

Featuring 3-ridge star carbides, this chain is centred by centrifugal force when in use providing greater protection to damaged and/or fragile pipes. Suitable for use in clay, concrete and cast iron pipes



Available in DN70 for 8mm shaft (**1381084070**), DN100 for 8mm shaft (**1381084100**), DN125 for 8mm shaft (**1381084125**), DN150 for 8mm shaft (**1381084150**), DN70 for 10mm shaft (**1381105070**), DN100 for 10mm shaft (**1381105100**), DN125 for 10mm shaft (**1381105125**), DN150 for 10mm shaft (**1381105150**), DN70 for 12mm shaft (**1381125070**), DN100 for 12mm shaft (**1381125100**), DN125 for 12mm shaft (**1381125125**), DN150 for 12mm shaft (**1381125150**), DN200 for 12mm shaft (**1381125200**), DN225 for 12mm shaft (**1381125225**), and DN250 for 12mm shaft (**1381125250**)

### Cyclone Premium Chains

A larger, heavier version of Picote's Cyclone Standard Chain that is stronger and faster than any other chain on the market. For tough descaling, hard deposits and removing residual concrete or failed liner



Available in DN70 for 8mm shaft (**1381084070U**), DN100 for 8mm shaft (**1381084100U**), DN125 for 8mm shaft (**1381084125U**), DN70 for 12mm shaft (**1381125070U**), DN100 for 12mm shaft (**1381125100U**), DN125 for 12mm shaft (**1381125125U**), DN150 for 12mm shaft (**1381125150U**), DN200 for 12mm shaft (**1381125200U**), DN225 for 12mm shaft (**1381125225U**), and DN250 for 12mm shaft (**1381125250U**)

### Cleaning Chains

This chain has no carbides and is to be used with the Picote Mini Cleaner



Available in DN32 for 8mm shaft (**1381084032**) and DN40 for 8mm shaft (**1381084040**)

### Original PVC Chains

This chain contains no carbides and can quickly clear fragile pipes such as those made of plastic, copper and clay of minor blockages and light roots



Available in DN50 for 8mm shaft (**1380084050P**), DN70 for 8mm shaft (**1380084070P**), DN100 for 8mm shaft (**1380084100P**), DN125-150 (**1380084150P**), DN70 for 10mm shaft (**1380105070P**), DN100 for 10mm shaft (**1380105100P**), DN125-150 for 10mm shaft (**1380105150P**), DN70 for 12mm shaft (**1380125070P**), DN100 for 12mm shaft (**1380125100P**), DN125-150 for 12mm shaft (**1380125150P**), and DN200 for 12mm shaft (**1380125200P**)

### Original Premium Chains



This chain features heavier and larger carbides which make it stronger and faster than any other chain on the market. A versatile tool for cast iron pipes, it's ideal for tough descaling, hard deposits and removing residual concrete or failed liner, including inconsistencies, wrinkles and remains

Available in DN50 (2 links) for 8mm shaft (**1380084050U**), DN50 (3 links) for 8mm shaft (**138084050U**), DN70 for 8mm shaft (**1380084070U**), DN100 for 8mm shaft (**1380084100U**), DN125-150 for 8mm shaft (**1380084150U**), DN70 for 12mm shaft (**1380125070U**), DN100 for 12mm shaft (**1380125100U**), DN125-150 for 12mm shaft (**1380125150U**), DN200 for 12mm shaft (**1380125200U**), DN225-250 for 12mm shaft (**1380125225U**), DN100 for 18mm shaft (**1380185100U**), DN125-150 for 18mm shaft (**1380185150U**), DN200 for 18mm shaft (**1380185200U**), DN225-250 for 18mm shaft (**1380185225U**), and DN300 for 18mm shaft (**1380185300U**)



### Original Standard Chains

With the exception of the DN32 - 6mm shaft model, all of Picote's Original Standard Chains feature 3-ridge star carbides resulting in an efficient general cleaning chain that's suitable for clay, concrete and cast iron pipes

Available in DN32 for 6mm shaft (**1380065032**), DN50 (2 links) for 8mm shaft (**130084050**), DN50 (3 links) for 8mm shaft (**1380184050**), DN70 for 8mm shaft (**1380084070**), DN100 for 8mm shaft (**1380084100**), DN125-150 for 8mm shaft (**1380084150**), DN70 for 10mm shaft (**1380105070**), DN100 for 10mm shaft (**1380105100**), DN125-150 (**1380105150**), DN70 for 12mm shaft (**1380125070**), DN100 for 12mm shaft (**1380125100**), DN125-150 for 12mm shaft (**1380125150**), DN200 for 12mm shaft (**1380125200**), and DN225-250 for 12mm shaft (**1380125225**)



### Tiger Original Chains

Designed for cast iron pipes, Picote's Tiger Chains feature long lasting and tough carbide teeth for a durable but gentle cleaning option

Available in DN50 for 8mm shaft (**1380084050V**), DN75 for 8mm shaft (**1380084070V**), DN100 for 8mm shaft (**1380084100V**), DN150 for 8mm shaft (**1380084150V**), DN75 for 10mm shaft (**1380105070V**), DN100 for 10mm shaft (**1380105100V**), DN150 for 10mm shaft (**1380105150V**), DN200 for 10mm shaft (**1380105200V**), DN75 for 12mm shaft (**1380125070V**), DN100 for 12mm shaft (**1380125100V**), DN150 for 12mm shaft (**1380125150V**), DN200 for 12mm shaft (**1380125200V**), and DN225-250 for 12mm shaft (**1380125250V**)

### Picote Grabber

Picote's Grabber can be used to retrieve items from or remove small blockages from DN100 pipes, saving companies time and money. Has a maximum range of 10 metres that can be extended to 30 metres. Comes with two sets of jaws.

The Picote Grabber is available in small (for DN50 pipes and larger), standard (for DN100 pipes and larger) and large (for DN150 pipes and larger). All variations, as well as their part numbers, can be found below

Available in Small (5 metre range and 1 jaw type (**2370000020**)), Small (10 metre range and 1 jaw type (**2370000021**)), Small (5 metre range and 2 jaw types (**2370000022**)), Small (10 metre range and 2 jaw types (**2370000023**)), Standard (**2370000001**), and Large (**2370000010**)



### Picote Grabber Extension

Extends the Picote Grabber's range by 10 metres. Includes connection piece. Only available for standard and large grabber models.

10 metre extension for Standard Grabber (**2370000001**) and 10 metre extension for Large Grabber (**2370000012**)



### Picote Grabber Steering Unit - 2370000014

Spare steering unit for the Picote Grabber and Picote Large Grabber.



### Picote Grabber Head with Jaws

Spare jaws and grabber heads for the Picote Grabber and Large Picote Grabber.

For Standard Grabber - **2370000009** / For Large Grabber - **2370000013**



### Small Grabber Jaw Sets

Jaw Sets for Picote's Small Grabber. Choose Set 1 for picking up rounded and smooth items. Choose Set 2 for picking up chains and debris with clear grabbing points.

Set 1 for DN50 (**2370000024**), Set 2 for DN50 (**2370000025**), Set 1 for DN70 (**2370000026**), and Set 2 for DN70 (**2370000027**)



### Small Grabber Jaw Sets

Jaw Sets for Picote's Small Grabber. Choose Set 1 for picking up chains, debris with clear grabbing points. Choose Set 2 for picking up rounded and smooth items. Set 3 features longer jaws that make it easier to use the Picote Grabber in larger pipes.

Set 1 (**2370000003**), Set 2 (**2370000004**) and Set 3 (**2370000006**)





**Large Grabber Jaw Sets - 2370000011**

Set of spare jaws for Picote's Large Grabber



**Picote Shaft Extensions - 12mm shaft**

Extension shafts form Picote's millers. Available in 5m (**1312020125005**), 10m (**1312020125010**), 15m (**1312020125020**) and 20m (**1312020125020**).

Also available with a thicker casing in 10m (**1312021125010**), 20m (**1312021125020**), 25m (**1312021125025**), and 30m (**1312021125030**).

**Picote Starter Kits**



**Starter Kit for DN100, 8mm Shaft - 1011008100**

Starter Kit for cleaning and descaling. Includes a Tiger Drill Chain, Smart Cutter, Cyclone Premium Chain, Original PVC Chain and a Combo Hex Key.



**Starter Kit for DN100, 12mm Shaft - 1011012100**

Starter Kit for cleaning and descaling. Includes a Tiger Drill Chain, Smart Cutter, Cyclone Premium Chain, Original PVC Chain and a Combo Hex Key.



**Starter Kit for DN150, 12mm Shaft - 1011012100**

Starter Kit for cleaning and descaling. Includes a Tiger Drill Chain, Smart Cutter, Cyclone Premium Chain, Original PVC Chain and a Combo Hex Key.







**Gas Alert MicroClip XL 4-Gas**

The compact multi-gas detector offers visual compliance with IntelliFlash and simple one-button operation.

**Available as EX Rated**  
**Please call us for prices**



**TLKR T40 Walkie – Talkies**

MOTOROLA TLKR T40 Twin Pack up to 4km range Free calls

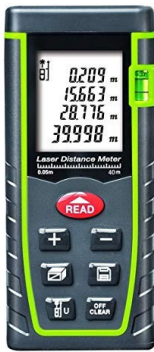

**40M Laser Distance Meter**



**Oregon Q515063 Browguard and Polycarbonate Visor**



**inspection Chamber Entry Kit**

Ensure you can enter manholes safely with our manhole entry kit comprised of a tripod, winch and harness.

**Please call us for prices**



**Emergency Evacuation Breathing Device**

Ensure you can enter manholes safely with our manhole entry kit comprised of a tripod, winch and harness.

**Please call us for prices**



**Round Bowl Gulley Grab - 88mm Bowl**

Simple and effective tool for removing debris and obstructions from within manholes, rain water gullies, drains and septic tanks.

**Lengths: 1m, 1.5m, 2m**



**Round Bowl Gulley Grab - 130mm Bowl**

Simple and effective tools for removing debris and obstructions from within manholes, rain water gullies, drains and septic tanks.

**Lengths: 1.5m, 2m**



**Square Bowl Gulley Grab - 150mm Bowl** Simple and effective tools for removing debris and obstructions from within manholes, rain water gullies, drains and septic tanks.

**Lengths: 1.5m, 2m**

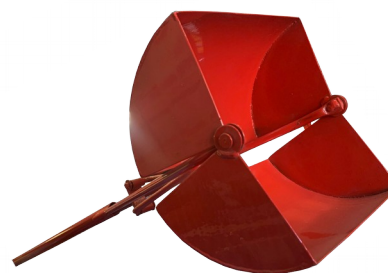

**Square Bowl Gulley Grab – 230mm x 2.5m**

Simple and effective tools for removing debris and obstructions from within manholes, rain water gullies, drains and septic tanks.



**GRABBIT O.M.O.**

A one man operated tool designed to lift debris covers etc in confined space.



**13mm Coiled Spring Rods**

13mm Coiled Spring Rods and Tools are more suited for plumbing type tasks such as waste pipes from a bath and sink or urinal.



**RIDGID**



**Drain Cleaner K-45AF (230V)**

Advanced two-way AUTOFEED® control keeps hands and work area clean – advances & retrieves cable with the push of a lever.



**RIDGID**



**Ridgid FLEXShaft Drain Cleaning Machine**

**RIDGID**



**Micro CA-350 Inspection Camera**

Documentation made easy with the RIDGID® micro CA-300 Inspection Camera, the next evolution of the microEXPLORER®



**Amtech Inspection Camera**

DIY maintenance and diagnostic tasks as well as automotive and heating With this handy tool you can view remote areas that are usually inaccessible and difficult to inspect such as pipes, engines, electronics, and under floor.



**33kHz Super Probe**

Transmits on 33kHz and can be normally located to a maximum depth of 15 metres



**C.SCOPE**



**Metal Locator**

Locate the position of metal buried under earth and tarmac.



## C.SCOPE



### DXL4 Locator

Can determine the exact location and depth of buried pipes, cables and respond immediately.

\*GPS and Bluetooth options available

## C.SCOPE



### MXL4 Locator

Features a multi frequency detection including 33KHz & 512Hz, which is beneficial when detecting smaller buried cables.

\*GPS and Bluetooth options available

## RIDGID



### NaviTrack Scout Locator

The fast search method navigates you faster to the right place. Precise: Includes a mapping display to confirm your location

## RIDGID



### 512Hz Battery Sonde

Compatible with most 512Hz equipment and, dependent on ground conditions, typically detectable to 5m



## C.SCOPE



### 33kHz Sonde

Small battery powered transmitter used in drainage applications to detect blockages or to aid plastic pipe tracing - 5m depth range

## C.SCOPE



### 512hz Sonde

This battery powered Sonde transmits a 512hz signal and is detectable up to 5 metres. It is ideal for locating blockages in metal pipes.



**3" The original heavy duty super flexible Tiger Tail**  
Suitable for jetting hoses and camera cables

**2" Semi Rigid medium duty protection Tail**  
Suitable for jetting hoses and camera cables



**Blue Safety Leading Hose**

3m (10') long with 1/2" bsp fittings. Maximum working pressure 4000psi. Warns the operator that the nozzle is near the manhole.



**3pc DIY Protection Set**



**Litter Picker**



**Measuring Wheel**  
Stock No. 44238



**5L Weed Sprayer**



**20W Rechargeable LED Work light**



**NightSearcher Magnetic Hazard Warning Light Available in Red, Blue, Green and Yellow**



**Cree LED Rechargeable Head Torch**

**IN CAR CHARGER INCLUDED**



**UNILITE Industrial High Power Li-ion Headlight PS-HDL9R**

**IN CAR CHARGER INCLUDED**



**LED DCR Torch**



**Wolf Safety M-60, ATEX LED Torch**



**Centre Locking Drain Test Plug – Nylon**  
**100mm/4” 150mm/6”**



**Centre Locking Drain Test Plug – Aluminium**  
**100mm/4” 150mm/6”**



**Centre Locking Drain Test Plug – Steel**  
**100mm/4” 150mm/6”**



**225mm/9” Steel Centre Locking Drain Test Plug**

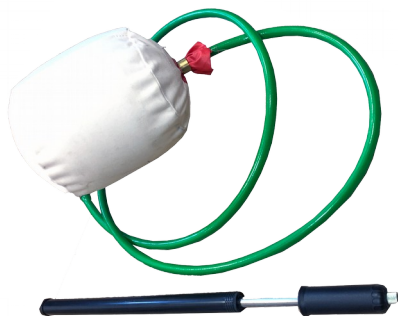

**Airbag Stoppers**  
 Inserted into the pipe and inflated using a standard bike pump

## AccessPoint

**The AccessPoint kit includes:**

- 10 x Access Points
- 1 x De-burring tool
- 1 x 6mm Allen Key
- 1 x 54mm Diamond Core Drill

**AccessPoint bungs also available**



# Lockfast Rods

## DRAIN ROD SIZE Sold in packs of 10

1m x 19mm  
1.5m x 19mm  
2m x 19mm

1m x 22mm  
1.5m x 22mm  
2m x 22mm

1m x 25mm  
1.5m x 25mm  
2m x 25mm

1m x 28mm  
1.5m x 28mm  
2m x 28mm

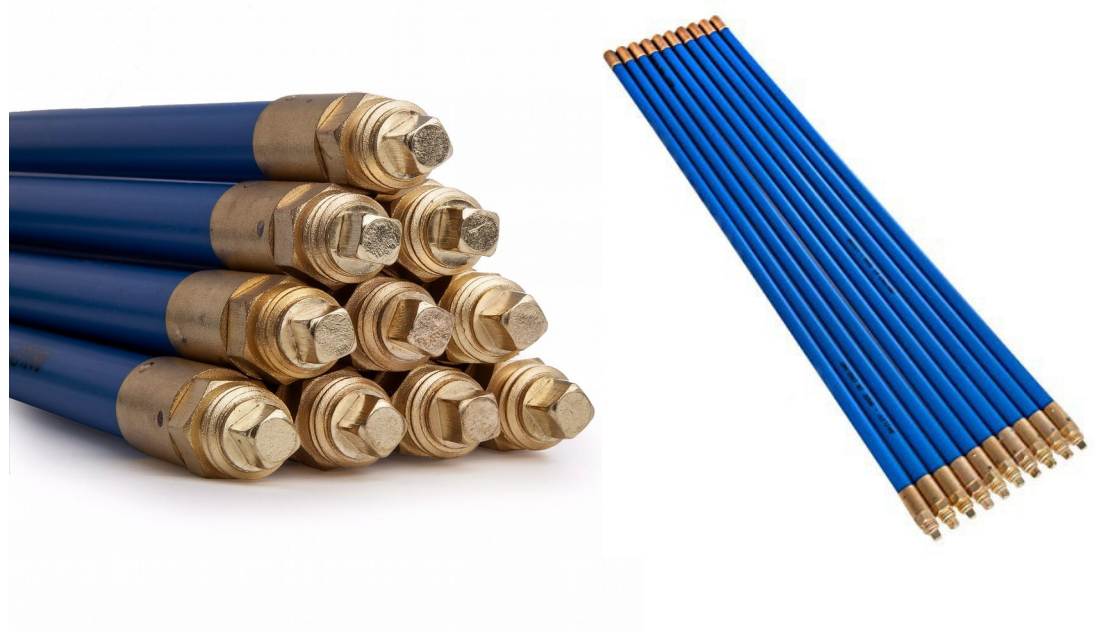

## Why *Lockfast*?

*These Lockfast rods are manufactured from the highest grade of polypropylene whilst the joints are manufactured from solid brass.*

*To ensure strength and durability during use the brass joints are securely fitted to the rods by brass rivets. Rods fitted with this type of joint can be rotated at either direction and will remain secure in the most demanding conditions*

## Popular *Lockfast* Attachments



Double Worm Screw



Crown Cutter



Drop Scraper



Lockfast Plunger





**Crown Root Cutter - 4" / 6" / 9"**

Dual purpose tool for cutting fibrous roots and silt breaking. Available in various sizes.



**Jointed Scraper - 4" / 6" / 9"**

For dragging silt from drains. Available in various sizes.



**Double Worm Screw - 4"**

Wound into obstruction until grips hold of blockage such as roots. Available in various sizes.



**Rotating Handle**

Lockfast rods can be rotated in either direction. Universal rods rotate in clockwise direction only.



**Retrieving Tool**

For recovery of loose rods in drains.



**Dust Chute Harpoon**

Useful tool for clearing blockages in dust chutes, pipes etc.



**Boring Tool**

For breaking through hard substances



**Diamond-Shaped Spearhead**

For dislodging debris in pipes. Used with a Steelkane rod.



**Rubber Plunger Head - 4"**

For plunging blockages in traps. For use with lock fast rods

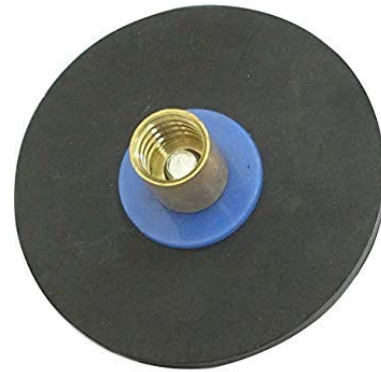

**Rubber Plunger Head - 6"**

For plunging blockages in traps. For use with lock fast rods

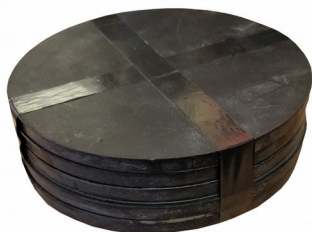

**Pack of 5 Rubber Plungers - 4"**

Pack of 5 rubber disc replacements for plungers.

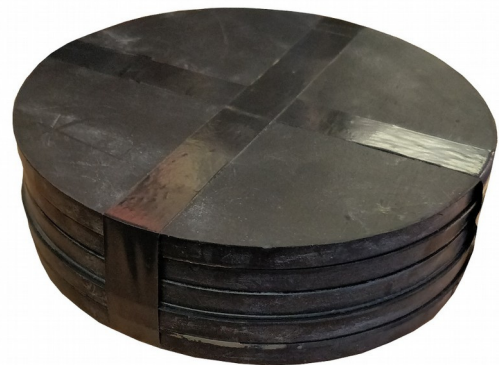

**Pack of 5 Rubber Plungers - 6"**

Pack of 5 rubber disc replacements for plungers.

# ROAD SAFETY SIGNS



## TRIPODS



FROM LIGHTWEIGHT TO MOTORWAY USE AVAILABLE,  
FOR MORE INFORMATION & PRICES PLEASE CALL US ON 01443 841540

# 10% OFF WITH ANY 10 KITS

DESCRIPTION
100mm x 500mm Repair Kit
150mm x 500mm Repair Kit
225mm x 500mm Repair Kit
300mm x 500mm Repair Kit
375mm x 500mm Repair Kit
450mm x 500mm Repair Kit
525mm x 500mm Repair Kit
100mm x 1M Repair Kit
150mm x 1M Repair Kit
225mm x 1M Repair Kit
300mm x 1M Repair Kit
375mm x 1M Repair Kit
450mm x 1M Repair Kit
525mm x 1M Repair Kit
100mm Radius
150mm Radius

## Why Straight PipeAid?

*Straight Pipe Repairs are suitable for repairs on a straight section of pipe, of between 100mm (4") and 525mm (21") diameter.*

## Why Radius PipeAid?

*Radius Pipe Repairs are suitable for pipe repairs on a 90° bend, from 100mm (4") to 225mm (9") diameter.*



## PIPE AID STARTER PACK



The Pipe Aid Starter Pack contains everything you need to begin pipe-repair work. The pack is comprised of:

- 240V, 25L Oil-Free Compressor
- 100mm-150mm x 1m long inflatable packer
- 10 x 1.5m Air Push-rods
- Flexible Adaptor
- Pressure Regulator

Patches not included, please see above for prices

### Included

PA100 100mm x 500mm and PA150 150mm x 500mm repair kits
10 x Air Push Rod Blue 1.5m Long
Pressure Regulator
Flexible Adaptor
25 Litre Portable Compressor



**AVAILABLE TO HIRE**

**KeyTec Mega Duty Set**

High leverage unseating hook, lifting key package (three pairs), combined tool bag for spreader bar, lifting keys and unseating hook.



**AVAILABLE TO HIRE**

**Magnetic Manhole Lifter**

MagTec Mega Magnet requires no external power or recharging. A simple lever with a safety interlock On-Off control.



**D.A.D. Lifting Key Set**

Made from carbon steel to give added strength and then zinc plated to protect from rust. Comes with 18-piece interchangeable tip kit



**Forged Lifting Key**

Heavy duty forged tip keys with 140mm wide triangular handle. Sold in pairs.



**Forged Lifting Key - T Handle**

Heavy duty forged tip keys with 'T' 300mm wide handle. Sold in pairs.



**2 x 130mm Manhole Keys**

Stock No. 89721



SUITABLE FOR ELECTRICAL INDUSTRY

**Heavy Duty Oval Handle Hook Key**

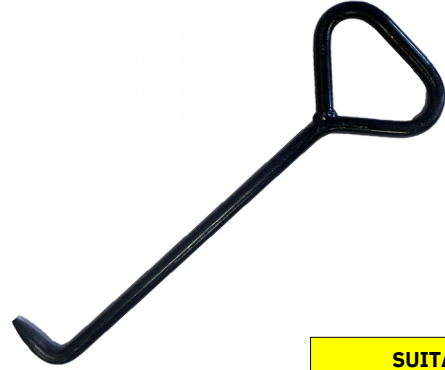

SUITABLE FOR ELECTRICAL INDUSTRY

**Light Duty Triangle Handle Hook Key**



**3 Piece Go-Thru Pry Bar Set**



**5pc Jumbo Pry Bar Set**



**Chisel**  
Chisel with 20mm blade.



**Strong Retrieval Magnet, 20m Rope & Gloves**



**36" Crowbar**



**Crowbars**

30" or 12" crowbar, manufactured from heavy-duty drop-forged steel.



**Steel Wedge**



**60" Heavy Duty Wrecking Bar**



**5m x 18mm Measuring Tape**



**45pc Stubby Tool Set**



**14" Pipe Wrench**



**8" Adjustable Wrench**



**9pc Metric Ball-end Allen Key Set**



**8pc Torx Allen Key Set**



**Lump Hammer**

2kg lump hammer with steel head, fibreglass shaft and rubber grip.



**8mm Flat Head Screwdriver**





**24" Square Mouth Shovel**



**28" Pointed Shovel – Fibreglass Handle**



**Metal Coal Shovel**



**4pc 25mm x 4.5m Ratchet Tie-Down Set**



**Drain Buster**



**Bungee Cord**

90cm - 150cm heavy duty bungee cord with aluminium carabiner clips.



**Siphon Drum Anti freeze Pump**

Stock No. 13420



**5 Gallon Drum Antifreeze**

Stock No. 13420



**Gen-X Nitrile Examination Gloves**

Available in packs of 100 or 1,000 pairs



**Showa Biodegradable Single-Use Gloves**

These single-use gloves from Showa are tough and durable. They are also latex and silicone free, and biodegradable.



**Long John Gloves from Showa**

These long nitrile gloves from Showa provide protection from acids, oils and chemicals.



**Long Arm Waterproof Work Gloves**

Abrasion resistant and flexible, suitable for industrial use.



**Cleaning Kit**

Contains 2 x brake cleaner, 1 x chain wax, 2 x toothbrush, 1 x cleaning cloth.



**Brake Cleaner**

Quick and easy to use; with its effective formula, it allows you to clean dirt and grime from brakes.



**Antibacterial Alcohol Hand Gel**

No water required, convenient hand sanitiser.



**Pine Disinfectant 5 litres**

For general cleaning and disinfecting after a spillage, leaving a pleasant pine fragrance.



**Acrylic Line Marker**

Hard-wearing and highly-visible line-marking paint, to give you sharp long-lasting lines that won't wash away in the rain.

Colours available: black, white, red, blue, yellow.



**HydroSnake®**

UK & Europe's best-selling sandless sandbag for flood protection & pollution control  
Absorbs up to 20kg of water in 2-3 minutes  
2 per pack  
Dimensions – 250(W)x1450(L)mm



**Vehicle First Aid Kit - Medium**

1x trauma dressing, 1x first aid dressing, 1x triangular bandage, 10x sterile wipes, 10x wash-proof plasters, 2x nitrile gloves, 1x face shield, 1x foil blanket, 1x adherent dressing.



**Eye wash kit**



**Visor and Goggle Anti-fog Spray**

Prevents visors and goggles from fogging by causing condensation to bead and roll off.  
Minimum order, Box of 12



**Clear Lens Safety Glasses**

Panoramic polycarbonate lenses with moulded side shields and brow guards.



**Elasticated Overshoes**

Pack of 100 elasticated shoe covers.



**6 Pack of Blue Roll**

# DCR

INSPECTION SYSTEMS LTD

## OUR DRAINAGE SUPERSTORE

Come see us at Unit 7C1,  
Codecae Lane, Hepworth Park,  
Pontyclun, CF72 9FQ

Or view our stock online at  
[www.draincamerarepairs.co.uk](http://www.draincamerarepairs.co.uk)



# DCR

INSPECTION SYSTEMS LTD

## REFURBISHED EQUIPMENT



At DCR, we aim to be able to fulfil the needs of all of our customers, whether they are looking for new, used or even hire equipment. We now hold a wide range of refurbished drainage CCTV equipment from all of the leading brands.

Our refurbished equipment is repaired and serviced by DCR with a 6 month warranty



### Refurbished Brands

- Ipek
- Ridgid
- Minicam
- Ibos
- Pearpoint
- Hippo 400
- C.Scope

## FOLLOW US ON SOCIAL MEDIA

Make sure to follow DCR Inspection Systems on social media and you'll be the first to hear special offers, our latest refurb, new additions to our hire fleet, stock updates, and more!

You'll find us on:



@DCRinspectionsystems



Search for DCR Inspection Systems Ltd



@DCR\_inspection\_systems

ALL PRICES SUBJECT TO CHANGE

# DCR HIRE

*Nationwide delivery  
available*



## Opening Times

Monday:	0800 - 1700	DCR Inspection Systems	
Tuesday:	0800 - 1700	Unit 7C1	
Wednesday:	0800 - 1700	Hepworth Parc	01443 841 540
Thursday:	0800 - 1700	Coedcae Lane	sales@draincamerarepairs.co.uk
Friday:	0800 - 1700	Pontyclun	hire@draincamerarepairs.co.uk
		CF72 9FQ	service@draincamerarepairs.co.uk